

# **LECTURE NOTE**

**COURSE CODE BCE1504**

**ENVIRONMENTAL ENGINEERING**

### **Disclaimer**

This document does not claim any originality and cannot be used as a substitute for prescribed textbooks. The information presented here is merely a collection by the committee members for their respective teaching assignments for the students of 5<sup>th</sup> semester B.Tech Civil Engineering of VSSUT, Burla. We would like to acknowledge various sources like freely available materials from internet from which the lecture note was prepared. The ownership of the information lies with the respective authors or institutions. Further, this document is not intended to be used for commercial purpose and the committee members are not accountable for any issues, legal or otherwise, arising out of use of this document. The committee members make no representations or warranties with respect to the accuracy or completeness of the contents of this document and specifically disclaim any implied warranties of merchantability or fitness for a particular purpose.

## **BCE 1504-ENVIRONMENTAL ENGINEERING (3-1-0) CR-04**

### **Module I (10 Hours)**

Quantity of water: Per-capita demand, design period, population forecast, fluctuation in demand.  
General requirement for water supply: Sources, Types of intakes, Pumping and Transportation of water.

Quality of water: Physical, chemical and biological characteristic of water and their significance, water quality criteria and standards.

### **Module II (10 Hours)**

Engineered system for water purification: Aeration, Coagulation and Flocculation, Sedimentation, Softening, Filtration, Disinfection, Water distribution systems.

Method of treatment: removal of colour, taste and odour control, algicid treatment, removal of iron and manganese, fluoridations.

### **Module III (10 Hours)**

Generation and collection of wastewater, sanitary, storm and combined sewerage systems, quantities of sanitary wastes and storm water, design of sewerage system.

Engineered system for wastewater treatment: Primary treatment: Screening, Grit removal, Sedimentation, sedimentation aided with coagulation.

Secondary treatment: Basics of microbiology, Growth and food utilization, Suspended-culture systems, Attached-culture systems, Secondary clarification, Disinfection of effluents.

Sludge treatment and disposal: Sludge characteristics, thickening, disposal.

### **Module IV (10 Hours)**

Air pollution: Units of measurement, sources and classification of air pollutants.

Influence of meteorological phenomena on air quality: Lapse rate and Dispersion, Pressure systems and dispersion, Winds and dispersion, Moisture and dispersion, Gaussian dispersion equation, Determination of stack heights.

Engineered systems for air pollution control: Gravitational settling chamber, cyclone, ESP, Bag filter and scrubbers, National Ambient Air quality Standards.

### **Text Books:**

1. Environmental Engineering (Volume I & II) by S. K. Garg – Khanna Publishers
2. Environmental Engineering (Volume I & II) by B. C. Punmia – Khanna Publishers
3. Environmental Engineering by H.S. Peavy, D. R. Rowe and G. Tchobanoglous, MGH.
4. Environmental Impact Assessment by Larry W. Canter, McGraw Hill.

# LECTURE-1

## Module-1

### Raw Water Source

The various sources of water can be classified into two categories:

1. Surface sources, such as
  - a. Ponds and lakes;
  - b. Streams and rivers;
  - c. Storage reservoirs; and
  - d. Oceans, generally not used for water supplies, at present.
2. Sub-surface sources or underground sources, such as
  - a. Springs;
  - b. Infiltration wells ; and
  - c. Wells and Tube-wells.

### Water Quantity Estimation

The quantity of water required for municipal uses for which the water supply scheme has to be designed requires following data:

1. Water consumption rate (***Per Capita Demand in litres per day per head***)
2. Population to be served.

**Quantity= Per capita demand x Population**

### Water Consumption Rate

It is very difficult to precisely assess the quantity of water demanded by the public, since there are many variable factors affecting water consumption. The various types of water demands, which a city may have, may be broken into following classes:

Water Consumption for Various Purposes:

	Types of Consumption	Normal Range (lit/capita/day)	Average	%
1	Domestic Consumption	65-300	160	35
2	Industrial and Commercial Demand	45-450	135	30
3	Public Uses including Fire Demand	20-90	45	10
4	Losses and Waste	45-150	62	25

### **Fire Fighting Demand:**

The per capita fire demand is very less on an average basis but the rate at which the water is required is very large. The rate of fire demand is sometimes treated as a function of population and is worked out from following empirical formulae:

	Authority	Formulae (P in thousand)	Q for 1 lakh Population)
1	American Insurance Association	$Q \text{ (L/min)}=4637 \sqrt{P} (1-0.01\sqrt{P})$	41760
2	Kuchling's Formula	$Q \text{ (L/min)}=3182 \sqrt{P}$	31800

3	Freeman's Formula	$Q \text{ (L/min)} = 1136.5(P/5+10)$	35050
4	Ministry of Urban Development Manual Formula	$Q \text{ (kilo liters/d)} = 100 \sqrt{P}$ for $P > 50000$	31623

#### Factors affecting per capita demand:

- Size of the city: Per capita demand for big cities is generally large as compared to that for smaller towns as big cities have sewered houses.
- Presence of industries.
- Climatic conditions.
- Habits of people and their economic status.
- Quality of water: If water is aesthetically & medically safe, the consumption will increase as people will not resort to private wells, etc.
- Pressure in the distribution system.
- Efficiency of water works administration: Leaks in water mains and services; and unauthorised use of water can be kept to a minimum by surveys.
- Cost of water.
- Policy of metering and charging method: Water tax is charged in two different ways: on the basis of meter reading and on the basis of certain fixed monthly rate.

#### Fluctuations in Rate of Demand

Average Daily Per Capita Demand

$$= \text{Quantity Required in 12 Months} / (365 \times \text{Population})$$

If this average demand is supplied at all the times, it will not be sufficient to meet the fluctuations.

- Seasonal variation:** The demand peaks during summer. Firebreak outs are generally more in summer, increasing demand. So, there is seasonal variation .
- Daily variation** depends on the activity. People draw out more water on Sundays and Festival days, thus increasing demand on these days.
- Hourly variations** are very important as they have a wide range. During active household working hours i.e. from six to ten in the morning and four to eight in the evening, the bulk of the daily requirement is taken. During other hours the requirement is negligible. Moreover, if a fire breaks out, a huge quantity of water is required to be supplied during short duration, necessitating the need for a maximum rate of hourly supply.

So, an adequate quantity of water must be available to meet the peak demand. To meet all the fluctuations, the supply pipes, service reservoirs and distribution pipes must be properly proportioned. The water is supplied by pumping directly and the pumps and distribution system must be designed to meet the peak demand. The effect of monthly variation influences the design of storage reservoirs and the hourly variations influences the design of pumps and service reservoirs. As the population decreases, the fluctuation rate increases.

**Maximum daily demand** = 1.8 x average daily demand

### **Maximum hourly demand of maximum day i.e. Peak demand**

- = 1.5 x average hourly demand
- = 1.5 x Maximum daily demand/24
- = 1.5 x (1.8 x average daily demand)/24
- = 2.7 x average daily demand/24
- = 2.7 x annual average hourly demand

### **Design Periods & Population Forecast**

This quantity should be worked out with due provision for the estimated requirements of the future . The future period for which a provision is made in the water supply scheme is known as the **design period**.

Design period is estimated based on the following:

- Useful life of the component, considering obsolescence, wear, tear, etc.
- Expandability aspect.
- Anticipated rate of growth of population, including industrial, commercial developments & migration-immigration.
- Available resources.
- Performance of the system during initial period.

### **Population Forecasting Methods**

The various methods adopted for estimating future populations are given below. The particular method to be adopted for a particular case or for a particular city depends largely on the factors discussed in the methods, and the selection is left to the discretion and intelligence of the designer.

1. Arithmetic Increase Method
2. Geometric Increase Method
3. *Incremental Increase Method*
4. Decreasing Rate of Growth Method
5. *Simple Graphical Method*
6. *Comparative Graphical Method*
7. Ratio Method
8. *Logistic Curve Method*

## **LECTURE-2**

### **Population Forecast by Different Methods**

**Problem:** Predict the population for the years 1981, 1991, 1994, and 2001 from the following census figures of a town by different methods.

Year	1901	1911	1921	1931	1941	1951	1961	1971
------	------	------	------	------	------	------	------	------

Population: (thousands)	60	65	63	72	79	89	97	120
----------------------------	----	----	----	----	----	----	----	-----

**Solution:**

Year	Population: (thousands)	Increment per Decade	per Incremental Increase	Percentage Increment per Decade
1901	60	-	-	-
1911	65	+5	-	$(5+60) \times 100 = +8.33$
1921	63	-2	-3	$(2+65) \times 100 = -3.07$
1931	72	+9	+7	$(9+63) \times 100 = +14.28$
1941	79	+7	-2	$(7+72) \times 100 = +9.72$
1951	89	+10	+3	$(10+79) \times 100 = +12.66$
1961	97	+8	-2	$(8+89) \times 100 = 8.98$
1971	120	+23	+15	$(23+97) \times 100 = +23.71$
Net values	1	+60	+18	+74.61
Averages	-	8.57	3.0	10.66

+ = increase; - = decrease

**Arithmetical Progression Method:**

$$P_n = P + ni$$

Average increases per decade =  $i = 8.57$

Population for the years,

$$1981 = \text{population } 1971 + ni, \text{ here } n=1 \text{ decade} \\ = 120 + 8.57 = 128.57$$

$$1991 = \text{population } 1971 + ni, \text{ here } n=2 \text{ decade} \\ = 120 + 2 \times 8.57 = 137.14$$

$$2001 = \text{population } 1971 + ni, \text{ here } n=3 \text{ decade} \\ = 120 + 3 \times 8.57 = 145.71$$

$$1994 = \text{population } 1991 + (\text{population } 2001 - 1991) \times 3/10 \\ = 137.14 + (8.57) \times 3/10 = 139.71$$

**Incremental Increase Method:**

Population for the years,

$$1981 = \text{population } 1971 + \text{average increase per decade} + \text{average incremental increase} \\ = 120 + 8.57 + 3.0 = 131.57$$

$$1991 = \text{population } 1981 + 11.57 \\ = 131.57 + 11.57 = 143.14$$

$$2001 = \text{population } 1991 + 11.57 \\ = 143.14 + 11.57 = 154.71$$

$$1994 = \text{population } 1991 + 11.57 \times 3/10 \\ = 143.14 + 3.47 = 146.61$$

**Geometric Progression Method:**

Average percentage increase per decade = 10.66

$$P_n = P (1+i/100)^n$$

Population for 1981 = Population 1971  $\times (1+i/100)^n$

$$= 120 \times (1+10.66/100), i = 10.66, n = 1$$

$$= 120 \times 110.66/100 = 132.8$$

$$\begin{aligned}
\text{Population for 1991} &= \text{Population 1971} \times (1+i/100)^n \\
&= 120 \times (1+10.66/100)^2, i = 10.66, n = 2 \\
&= 120 \times 1.2245 = 146.95 \\
\text{Population for 2001} &= \text{Population 1971} \times (1+i/100)^n \\
&= 120 \times (1+10.66/100)^3, i = 10.66, n = 3 \\
&= 120 \times 1.355 = 162.60
\end{aligned}$$

$$\text{Population for 1994} = 146.95 + (15.84 \times 3/10) = 151.70$$

## **LECTURE-3**

### **Intake Structure**

The basic function of the intake structure is to help in safely withdrawing water from the source over predetermined pool levels and then to discharge this water into the withdrawal conduit (normally called intake conduit), through which it flows up to water treatment plant.

### **Factors Governing Location of Intake**

1. As far as possible, the site should be near the treatment plant so that the cost of conveying water to the city is less.
2. The intake must be located in the purer zone of the source to draw best quality water from the source, thereby reducing load on the treatment plant.
3. The intake must never be located at the downstream or in the vicinity of the point of disposal of wastewater.
4. The site should be such as to permit greater withdrawal of water, if required at a future date.
5. The intake must be located at a place from where it can draw water even during the driest period of the year.
6. The intake site should remain easily accessible during floods and should not get flooded. Moreover, the flood waters should not be concentrated in the vicinity of the intake.

### **Design Considerations**

1. sufficient factor of safety against external forces such as heavy currents, floating materials, submerged bodies, ice pressure, etc.
2. should have sufficient self weight so that it does not float by upthrust of water.

### **Types of Intake**

Depending on the source of water, the intake works are classified as follows:

#### **Pumping**

A pump is a device, which converts mechanical energy into hydraulic energy. It lifts water from a lower to a higher level and delivers it at high pressure. Pumps are employed in water supply projects at various stages for following purposes:



1. To lift raw water from wells.
2. To deliver treated water to the consumer at desired pressure.
3. To supply pressured water for fire hydrants.
4. To boost up pressure in water mains.
5. To fill elevated overhead water tanks.
6. To backwash filters.
7. To pump chemical solutions, needed for water treatment.

### **Classification of Pumps**

Based on principle of operation, pumps may be classified as follows:

1. Displacement pumps (reciprocating, rotary)
2. Velocity pumps (centrifugal, turbine and jet pumps)
3. Buoyancy pumps (air lift pumps)
4. Impulse pumps (hydraulic rams)

### **Capacity of Pumps**

Work done by the pump,

$$\text{H.P.} = wQH/75$$

where,  $w$  = specific weight of water  $\text{kg/m}^3$ ,  $Q$  = discharge of pump,  $\text{m}^3/\text{s}$ ; and  $H$  = total head against which pump has to work.

$$H = H_s + H_d + H_f + (\text{losses due to exit, entrance, bends, valves, and so on})$$

where,  $H_s$  = suction head,  $H_d$  = delivery head, and  $H_f$  = friction loss.

$$\text{Efficiency of pump (E)} = wQH/\text{Brake H.P.}$$

$$\text{Total brake horse power required} = wQH/E$$

Provide even number of motors say 2,4, with their total capacity being equal to the total BHP and provide half of the motors required as stand-by.

### **Conveyance**

There are two stages in the transportation of water:

1. Conveyance of water from the source to the treatment plant.
2. Conveyance of treated water from treatment plant to the distribution system.

In the first stage water is transported by gravity or by pumping or by the combined action of both, depending upon the relative elevations of the treatment plant and the source of supply. In the second stage water transmission may be either by pumping into an overhead tank and then supplying by gravity or by pumping directly into the water-main for distribution.

## Free Flow System

In this system, the surface of water in the conveying section flows freely due to gravity. In such a conduit the hydraulic gradient line coincide with the water surface and is parallel to the bed of the conduit. It is often necessary to construct very long conveying sections, to suit the slope of the existing ground. The sections used for free-flow are: Canals, flumes, grade aqueducts and grade tunnels.

## Pressure System

In pressure conduits, which are closed conduits, the water flows under pressure above the atmospheric pressure. The bed or invert of the conduit in pressure flows is thus independent of the grade of the hydraulic gradient line and can, therefore, follow the natural available ground surface thus requiring lesser length of conduit. The pressure aqueducts may be in the form of closed pipes or closed aqueducts and tunnels called *pressure aqueducts or pressure tunnels* designed for the pressure likely to come on them. Due to their circular shapes, every pressure conduit is generally termed as a *pressure pipe*. When a pressure pipe drops beneath a valley, stream, or some other depression, it is called a depressed pipe or an *inverted siphon*. Depending upon the construction material, the pressure pipes are of following types: Cast iron, steel, R.C.C, hume steel, vitrified clay, asbestos cement, wrought iron, copper, brass and lead, plastic, and glass reinforced plastic pipes.

## Hydraulic Design

The design of water supply conduits depends on the resistance to flow, available pressure or head, and allowable velocities of flow. Generally, Hazen-William's formula for pressure conduits and Manning's formula for freeflow conduits are used.

Hazen-William's formula

$$U=0.85 C r_H^{0.63} S^{0.54}$$

Manning's formula

$$U=1/n r_H^{2/3} S^{1/2}$$

where, U= velocity, m/s;  $r_H$ = hydraulic radius,m; S= slope, C= Hazen-William's coefficient, and n = Manning's coefficient.

Darcy-Weisbach formula

$$h_L=(fLU^2)/(2gd)$$

The available raw waters must be treated and purified before they can be supplied to the public for their domestic, industrial or any other uses. The extent of treatment required to be given to the particular water depends upon the characteristics and quality of the available water, and also upon the quality requirements for the intended use..

The layout of conventional water treatment plant is as follows:

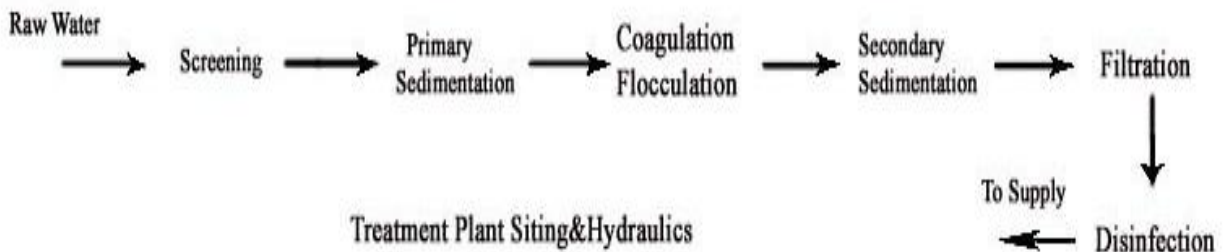

Depending upon the magnitude of treatment required, proper unit operations are selected and arranged in the proper sequential order for the purpose of modifying the quality of raw water to meet the desired standards. Indian Standards for drinking water are given in the table below.

## LECTURE-4

### Water Distribution Systems

The purpose of distribution system is to deliver water to consumer with appropriate quality, quantity and pressure. Distribution system is used to describe collectively the facilities used to supply water from its source to the point of usage.

#### **Requirements of Good Distribution System**

1. Water quality should not get deteriorated in the distribution pipes.
2. It should be capable of supplying water at all the intended places with sufficient pressure head.
3. It should be capable of supplying the requisite amount of water during fire fighting.
4. The layout should be such that no consumer would be without water supply, during the repair of any section of the system.
5. All the distribution pipes should be preferably laid one metre away or above the sewer lines.
6. It should be fairly water-tight as to keep losses due to leakage to the minimum.

#### **Layouts of Distribution Network**

The distribution pipes are generally laid below the road pavements, and as such their layouts generally follow the layouts of roads. There are, in general, four different types of pipe networks; any one of which either singly or in combinations, can be used for a particular place. They are:

*Dead End System*  
*Grid Iron System*  
*Ring System*  
*Radial System*

### Distribution Reservoirs

Distribution reservoirs, also called service reservoirs, are the storage reservoirs, which store the treated water for supplying water during emergencies (such as during fires, repairs, etc.) and also to help in absorbing the hourly fluctuations in the normal water demand.

#### **Functions of Distribution Reservoirs:**

- to absorb the hourly variations in demand.
- to maintain constant pressure in the distribution mains.
- water stored can be supplied during emergencies.

#### **Location and Height of Distribution Reservoirs:**

- should be located as close as possible to the center of demand.
- water level in the reservoir must be at a sufficient elevation to permit gravity flow at an adequate pressure.

#### **Types of Reservoirs**

1. Underground reservoirs.
2. Small ground level reservoirs.
3. Large ground level reservoirs.
4. Overhead tanks.

#### **Storage Capacity of Distribution Reservoirs**

The total storage capacity of a distribution reservoir is the summation of:

1. **Balancing Storage:** The quantity of water required to be stored in the reservoir for equalising or balancing fluctuating demand against constant supply is known as the balancing storage (or equalising or operating storage). The balance storage can be worked out by **mass curve method**.
2. **Breakdown Storage:** The breakdown storage or often called emergency storage is the storage preserved in order to tide over the emergencies posed by the failure of pumps, electricity, or any other mechanism driving the pumps. A value of about 25% of the total storage capacity of reservoirs, or 1.5 to 2 times of the average hourly supply, may be considered as enough provision for accounting this storage.
3. **Fire Storage:** The third component of the total reservoir storage is the fire storage. This provision takes care of the requirements of water for extinguishing fires. A provision of 1 to 4 per person per day is sufficient to meet the requirement.

The total reservoir storage can finally be worked out by adding all the three storages.

#### **Pipe Network Analysis**

Analysis of water distribution system includes determining quantities of flow and head losses in the various pipe lines, and resulting residual pressures. In any pipe network, the following two conditions must be satisfied:

1. The algebraic sum of pressure drops around a closed loop must be zero, i.e. there can be no discontinuity in pressure.
2. The flow entering a junction must be equal to the flow leaving that junction; i.e. the law of continuity must be satisfied.

Based on these two basic principles, the pipe networks are generally solved by the methods of successive approximation. The widely used method of pipe network analysis is the Hardy-Cross method.

### **Hardy-Cross Method**

This method consists of assuming a distribution of flow in the network in such a way that the principle of continuity is satisfied at each junction. A correction to these assumed flows is then computed successively for each pipe loop in the network, until the correction is reduced to an acceptable magnitude.

If  $Q_a$  is the assumed flow and  $Q$  is the actual flow in the pipe, then the correction  $d$  is given by

$$d = Q - Q_a; \text{ or } Q = Q_a + d$$

Now, expressing the head loss ( $H_L$ ) as

$$H_L = K \cdot Q^x$$

we have, the head loss in a pipe

$$= K \cdot (Q_a + d)^x$$

$$= K \cdot [Q_a^x + x \cdot Q_a^{x-1} d + \dots \dots \dots \text{negligible terms}]$$

$$= K \cdot [Q_a^x + x \cdot Q_a^{x-1} d]$$

Now, around a closed loop, the summation of head losses must be zero.

$$SK \cdot [Q_a^x + x \cdot Q_a^{x-1} d] = 0$$

$$\text{or } SK \cdot Q_a^x = - SKx \cdot Q_a^{x-1} d$$

Since,  $d$  is the same for all the pipes of the considered loop, it can be taken out of the summation.

$$SK \cdot Q_a^x = - d \cdot SKx \cdot Q_a^{x-1}$$

$$\text{or } d = -SK \cdot Q_a^x / Sx \cdot KQ_a^{x-1}$$

Since  $d$  is given the same sign (direction) in all pipes of the loop, the denominator of the above equation is taken as the absolute sum of the individual items in the summation. Hence,

$$\text{or } d = -SK \cdot Q_a^x / S | x \cdot KQ_a^{x-1} |$$

$$\text{or } d = -SH_L / x.S |H_L/Q_a|$$

where  $H_L$  is the head loss for assumed flow  $Q_a$ .

The numerator in the above equation is the algebraic sum of the head losses in the various pipes of the closed loop computed with assumed flow. Since the direction and magnitude of flow in these pipes is already assumed, their respective head losses with due regard to sign can be easily calculated after assuming their diameters. The absolute sum of respective  $KQ_a^{x-1}$  or  $H_L/Q_a$  is then calculated. Finally the value of  $d$  is found out for each loop, and the assumed flows are corrected. Repeated adjustments are made until the desired accuracy is obtained.

The value of  $x$  in Hardy- Cross method is assumed to be constant (i.e. 1.85 for Hazen-William's formula, and 2 for Darcy-Weisbach formula)

## LECTURE-5

### Flow in Pipes of a Distribution Network by Hardy Cross Method

**Problem:** Calculate the head losses and the corrected flows in the various pipes of a distribution network as shown in figure. The diameters and the lengths of the pipes used are given against each pipe. Compute corrected flows after one corrections.

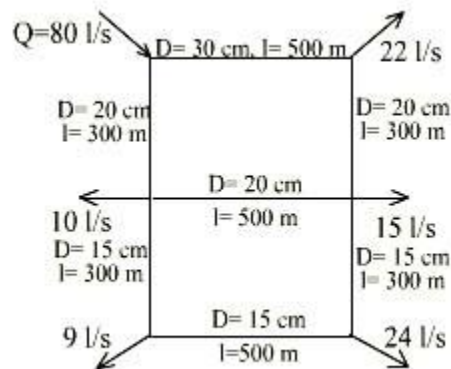

**Solution:** First of all, the magnitudes as well as the directions of the possible flows in each pipe are assumed keeping in consideration the law of continuity at each junction. The two closed loops, ABCD and CDEF are then analyzed by Hardy Cross method as per tables 1 & 2 respectively, and the corrected flows are computed.

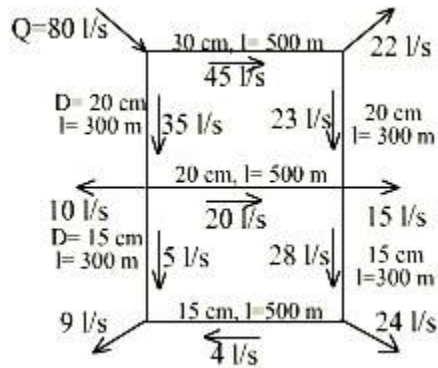

**Table 1**

**Consider loop ABCD**

Pipe	Assumed flow		Dia of pipe		Length of pipe (m)	K = $\frac{L}{470 d^{4.87}}$	$Q_a^{1.85}$	$H_L = K \cdot Q_a^{1.85}$	$ H_L/Q_a $
	in l/sec	in cumecs	d in m	$d^{4.87}$					
(1)	(2)	(3)	(4)	(5)	(6)	(7)	(8)	(9)	(10)
AB	(+) 43	+0.043	0.30	$2.85 \times 10^{-3}$	500	373	$3 \times 10^3$	+1.12	26
BC	(+)	+0.023	0.20	$3.95 \times 10^{-4}$	300	1615	9.4	+1.52	66
CD	23	-0.020	0.20	$3.95 \times 10^{-4}$	500	2690	$9.4 \times 10^{-4}$	-1.94	97
DA	(-) 20 (-) 35	-0.035	0.20	$3.95 \times 10^{-4}$	300	1615	$7.2 \times 10^{-4}$	-3.23	92
S				$3.95 \times 10^{-4}$			$2 \times 10^3$	-2.53	281

\*  $H_L = (Q_a^{1.85} L) / (0.094 \times 100^{1.85} \times d^{4.87})$   
or  $K \cdot Q_a^{1.85} = (Q_a^{1.85} L) / (470 d^{4.87})$   
or  $K = (L) / (470 \times d^{4.87})$

For loop ABCD, we have  $d = -S H_L / \sum |H_L / Q_a|$

$= (-) -2.53 / (1.85 \times 281)$  cumecs

$= (-) (-2.53 \times 1000) / (1.85 \times 281)$  l/s

$$=4.86 \text{ l/s} =5 \text{ l/s (say)}$$

Hence, corrected flows after first correction are:

Pipe	AB	BC	CD	DA
Corrected flows after first correction in l/s	+ 48	+ 28	- 15	- 30

**Table 2**

**Consider loop DCFE**

Pipe	Assumed flow		Dia of pipe		Length of pipe (m)	$K = \frac{L}{470 d^{4.87}}$	$Q_a^{1.85}$	$H_L = K \cdot Q_a^{1.85}$	$ H_L/Q_a $
	in l/sec	in cumecs	d in m	$d^{4.87}$					
(1)	(2)	(3)	(4)	(5)	(6)	(7)	(8)	(9)	(10)
DC	(+) 20	+0.020	0.20	$3.95 \times 10^{-4}$	500	2690	$7.2 \times 10^4$	+1.94	97
CF	(+) 28	+0.028	0.15	$9.7 \times 10^{-5}$	300	6580	1.34	+8.80	314
FE	(-) 8	-0.008	0.15	$9.7 \times 10^{-5}$	500	10940	$1.34 \times 10^{-3}$	-1.47	184
ED	(-) 5	-0.005	0.15	$9.7 \times 10^{-5}$	300	6580	$1.34 \times 10^{-4}$	-0.37	74
S				$9.7 \times 10^{-5}$			$5.6 \times 10^5$	+8.9	669

For loop ABCD, we have  $d = -\sum H_L / \sum |H_L/Q_a|$

$$=(-) +8.9/(1.85 \times 669) \text{ cumecs}$$

$$=(-) (+8.9 \times 1000)/(1.85 \times 669) \text{ l/s}$$

$$= -7.2 \text{ l/s}$$

Hence, corrected flows after first correction are:

Pipe	DC	CF	FE	ED
Corrected flows after first correction	+	+	-	-



correction in l/s	12.8	20.8	15.2	12.2
-------------------	------	------	------	------

## LECTURE-6

### Water Quality

The raw or treated water is analysed by testing their physical, chemical and bacteriological characteristics:

#### Physical Characteristics:

Turbidity  
 Colour  
 Taste and Odour  
 Temperature

#### Chemical Characteristics:

pH  
 Acidity  
 Alkalinity  
 Hardness  
 Chlorides  
 Sulphates  
 Iron  
 Solids  
 Nitrates

#### Bacteriological Characteristics:

Bacterial examination of water is very important, since it indicates the degree of pollution. Water polluted by sewage contain one or more species of disease producing pathogenic bacteria. Pathogenic organisms cause water borne diseases, and many non pathogenic bacteria such as **E. Coli**, a member of coliform group, also live in the intestinal tract of human beings. **Coliform** itself is not a harmful group but it has more resistance to adverse condition than any other group. So, if it is ensured to minimize the number of coliforms, the harmful species will be very less. So, coliform group serves as indicator of contamination of water with sewage and presence of pathogens.

The methods to estimate the bacterial quality of water are:

Standard Plate Count Test  
 Most Probable Number  
 Membrane Filter Technique

### Indian Standards for drinking water

Parameter	Desirable-Tolerable	<i>If no alternative source available, limit extended upto</i>
-----------	---------------------	--

<b>Physical</b>		
Turbidity (NTU unit)	< 10	25
Colour (Hazen scale)	< 10	50
Taste and Odour	Un-objectionable	Un-objectionable
<b>Chemical</b>		
pH	7.0-8.5	6.5-9.2
Total Dissolved Solids mg/l	500-1500	3000
Total Hardness mg/l (as CaCO <sub>3</sub> )	200-300	600
Chlorides mg/l (as Cl)	200-250	1000
Sulphates mg/l (as SO <sub>4</sub> )	150-200	400
Fluorides mg/l (as F )	0.6-1.2	1.5
Nitrates mg/l (as NO <sub>3</sub> )	45	45
Calcium mg/l (as Ca)	75	200
Iron mg/l (as Fe )	0.1-0.3	1.0

## LECTURE-7

### Module II

The typical functions of each unit operations are given in the following table:

Functions of Water Treatment Units

Unit treatment	Function (removal)
Aeration, chemicals use	Colour, Odour, Taste
Screening	Floating matter
Chemical methods	Iron, Manganese, etc.
Softening	Hardness
Sedimentation	Suspended matter
Coagulation	Suspended matter, a part of colloidal matter and bacteria
Filtration	Remaining colloidal dissolved matter, bacteria
Disinfection	Pathogenic bacteria, Organic matter and Reducing substances

The types of treatment required for different sources are given in the following table:

Source	Treatment required
1. Ground water and spring water fairly free from contamination	No treatment or Chlorination
2. Ground water with chemicals, minerals and gases	Aeration, coagulation (if necessary), filtration and disinfection
3. Lakes, surface water reservoirs with less amount of pollution	Disinfection
4. Other surface waters such as rivers, canals and impounded reservoirs with a considerable amount of pollution	Complete treatment

### Aeration

- Aeration removes odour and tastes due to volatile gases like hydrogen sulphide and due to algae and related organisms.
- Aeration also oxidise iron and manganese, increases dissolved oxygen content in water, removes CO<sub>2</sub> and reduces corrosion and removes methane and other flammable gases.

- Principle of treatment underlines on the fact that volatile gases in water escape into atmosphere from the air-water interface and atmospheric oxygen takes their place in water, provided the water body can expose itself over a vast surface to the atmosphere. This process continues until an equilibrium is reached depending on the partial pressure of each specific gas in the atmosphere.

### **Types of Aerators**

1. Gravity aerators
2. Fountain aerators
3. Diffused aerators
4. Mechanical aerators.

**Gravity Aerators (Cascades):** In gravity aerators, water is allowed to fall by gravity such that a large area of water is exposed to atmosphere, sometimes aided by turbulence.

**Fountain Aerators:** These are also known as spray aerators with special nozzles to produce a fine spray. Each nozzle is 2.5 to 4 cm diameter discharging about 18 to 36 l/h. Nozzle spacing should be such that each m<sup>3</sup> of water has aerator area of 0.03 to 0.09 m<sup>2</sup> for one hour.

**Injection or Diffused Aerators:** It consists of a tank with perforated pipes, tubes or diffuser plates, fixed at the bottom to release fine air bubbles from compressor unit. The tank depth is kept as 3 to 4 m and tank width is within 1.5 times its depth. If depth is more, the diffusers must be placed at 3 to 4 m depth below water surface. Time of aeration is 10 to 30 min and 0.2 to 0.4 litres of air is required for 1 litre of water.

**Mechanical Aerators:** Mixing paddles as in flocculation are used. Paddles may be either submerged or at the surface.

### **Settling**

Solid liquid separation process in which a suspension is separated into two phases –

- Clarified supernatant leaving the top of the sedimentation tank (overflow).
- Concentrated sludge leaving the bottom of the sedimentation tank (underflow).

### **Purpose of Settling**

- To remove coarse dispersed phase.
- To remove coagulated and flocculated impurities.
- To remove precipitated impurities after chemical treatment.
- To settle the sludge (biomass) after activated sludge process / tricking filters.

### **Principle of Settling**

- Suspended solids present in water having specific gravity greater than that of water tend to settle down by gravity as soon as the turbulence is retarded by offering storage.
- Basin in which the flow is retarded is called **settling tank**.
- Theoretical average time for which the water is detained in the settling tank is called the **detention period**.

## LECTURE-8

### Types of Settling

Type I: **Discrete particle settling** - Particles settle individually without interaction with neighboring particles.

Type II: **Flocculent Particles** – Flocculation causes the particles to increase in mass and settle at a faster rate.

Type III: **Hindered or Zone settling** –The mass of particles tends to settle as a unit with individual particles remaining in fixed positions with respect to each other.

Type IV: **Compression** – The concentration of particles is so high that sedimentation can only occur through compaction of the structure.

### Type I Settling

- Size, shape and specific gravity of the particles do not change with time.
- Settling velocity remains constant.

If a particle is suspended in water, it initially has two forces acting upon it:

**force of gravity:**  $F_g = \rho_p g V_p$

**Buoyant force** quantified by Archimedes as:  $F_b = \rho g V_p$

If the density of the particle differs from that of the water, a net force is exerted and the particle is accelerated in the direction of the force:  $F_{net} = (\rho_p - \rho) g V_p$

This net force becomes the driving force.

Once the motion has been initiated, a third force is created due to viscous friction. This force, called the **drag force**, is quantified by:  $F_d = C_D A_p \rho v^2 / 2$

$C_D$  = drag coefficient.

$A_p$  = projected area of the particle.

Because the drag force acts in the opposite direction to the driving force and increases as the square of the velocity, acceleration occurs at a decreasing rate until a steady velocity is reached at a point where the drag force equals the driving force:

$$(\rho_p - \rho) g V_p = C_D A_p \rho v^2 / 2$$

For spherical particles,

$$V_p = \frac{\pi d^3}{6} \text{ and } A_p = \frac{\pi d^2}{4}$$

$$\text{Thus, } v^2 = \frac{4g(\rho_p - \rho)d}{3C_D\rho}$$

Expressions for  $C_D$  change with characteristics of different flow regimes. For laminar, transition, and turbulent flow, the values of  $C_D$  are:

$$C_D = \frac{24}{Re} \text{ (laminar)}$$

$$C_D = \frac{24}{Re} + \frac{3}{Re^{1/2}} + 0.34 \text{ (transition)}$$

$C_D = 0.4$  (turbulent)

where  $Re$  is the Reynolds number:

$$Re = \frac{\rho v d}{\mu}$$

Reynolds number less than 1.0 indicate laminar flow, while values greater than 10 indicate turbulent flow. Intermediate values indicate transitional flow.

### **Stokes Flow**

For laminar flow, terminal settling velocity equation becomes:

$$v = \frac{(\rho_p - \rho)gd^2}{18\mu}$$

which is known as the **stokes equation**.

### **Transition Flow**

Need to solve non-linear equations:

$$v^2 = \frac{4g(\rho_p - \rho)d}{3C_D \rho}$$

$$C_D = \frac{24}{Re} + \frac{3}{Re^{1/2}} + 0.34$$

$$Re = \frac{\rho v d}{\mu}$$

- Calculate velocity using Stokes law or turbulent expression.
- Calculate and check Reynolds number.
- Calculate  $C_D$ .
- Use general formula.
- Repeat from step 2 until convergence.

### **Types of Settling Tanks**

- Sedimentation tanks may function either intermittently or continuously. The intermittent tanks also called quiescent type tanks are those which store water for a certain period and keep it in complete rest. In a continuous flow type tank, the flow velocity is only reduced and the water is not brought to complete rest as is done in an intermittent type.
- Settling basins may be either long rectangular or circular in plan. Long narrow rectangular tanks with horizontal flow are generally preferred to the circular tanks with radial or spiral flow.

### **Long Rectangular Settling Basin**

- Long rectangular basins are hydraulically more stable, and flow control for large volumes is easier with this configuration.
- A typical long rectangular tank have length ranging from 2 to 4 times their width. The bottom is slightly sloped to facilitate sludge scraping. A slow moving mechanical sludge

scraper continuously pulls the settled material into a sludge hopper from where it is pumped out periodically.

### **Drag of sedimentation tank**

A long rectangular settling tank can be divided into four different functional zones:

**Inlet zone:** Region in which the flow is uniformly distributed over the cross section such that the flow through settling zone follows horizontal path.

**Settling zone:** Settling occurs under quiescent conditions.

**Outlet zone:** Clarified effluent is collected and discharge through outlet weir.

**Sludge zone:** For collection of sludge below settling zone.

### **Inlet and Outlet Arrangement**

**Inlet devices:** Inlets shall be designed to distribute the water equally and at uniform velocities. A baffle should be constructed across the basin close to the inlet and should project several feet below the water surface to dissipate inlet velocities and provide uniform flow;

**Outlet Devices:** Outlet weirs or submerged orifices shall be designed to maintain velocities suitable for settling in the basin and to minimize short-circuiting. Weirs shall be adjustable, and at least equivalent in length to the perimeter of the tank. However, peripheral weirs are not acceptable as they tend to cause excessive short-circuiting.

### **Weir Overflow Rates**

Large weir overflow rates result in excessive velocities at the outlet. These velocities extend backward into the settling zone, causing particles and flocs to be drawn into the outlet. Weir loadings are generally used upto 300 m<sup>3</sup>/d/m. It may be necessary to provide special inboard weir designs as shown to lower the weir overflow rates.

### **Inboard Weir Arrangement to Increase Weir Length**



### **Circular Basins**

- Circular settling basins have the same functional zones as the long rectangular basin, but the flow regime is different. When the flow enters at the center and is baffled to flow radially towards the perimeter, the horizontal velocity of the water is continuously

decreasing as the distance from the center increases. Thus, the particle path in a circular basin is a parabola as opposed to the straight line path in the long rectangular tank.

- Sludge removal mechanisms in circular tanks are simpler and require less maintenance.

### **Settling Operations**

- Particles falling through the settling basin have two components of velocity:

1) Vertical component:  $v_t = \frac{(\rho_p - \rho)gd^2}{18\mu}$

2) Horizontal component:  $v_h = Q/A$

The path of the particle is given by the vector sum of horizontal velocity  $v_h$  and vertical settling velocity  $v_t$ .

- Assume that a settling column is suspended in the flow of the settling zone and that the column travels with the flow across the settling zone. Consider the particle in the batch analysis for type-1 settling which was initially at the surface and settled through the depth of the column  $Z_0$ , in the time  $t_0$ . If  $t_0$  also corresponds to the time required for the column to be carried horizontally across the settling zone, then the particle will fall into the sludge zone and be removed from the suspension at the point at which the column reaches the end of the settling zone.
- All particles with  $v_t > v_0$  will be removed from suspension at some point along the settling zone.
- Now consider the particle with settling velocity  $< v_0$ . If the initial depth of this particle was such that  $Z_p/v_t = t_0$ , this particle will also be removed. Therefore, the removal of suspended particles passing through the settling zone will be in proportion to the ratio of the individual settling velocities to the settling velocity  $v_0$ .
- The time  $t_0$  corresponds to the retention time in the settling zone.
- $t = \frac{V}{Q} = \frac{LZ_0W}{Q}$

Also,  $t_0 = \frac{Z_0}{v_0}$

Therefore,  $\frac{Z_0}{v_0} = \frac{LZ_0W}{Q}$  and  $v_0 = \frac{Q}{LW}$

or  $v_0 = \frac{Q}{A_s}$

Thus, the depth of the basin is not a factor in determining the size particle that can be removed completely in the settling zone. The determining factor is the quantity  $Q/A_s$ , which has the units of velocity and is referred to as the overflow rate  $q_0$ . This overflow rate is the design factor for settling basins and corresponds to the terminal setting velocity of the particle that is 100% removed.

### **Design Details**

1. Detention period: for plain sedimentation: 3 to 4 h, and for coagulated sedimentation: 2 to 2.5 h.
2. Velocity of flow: Not greater than 30 cm/min (horizontal flow).



3. Tank dimensions: L:B = 3 to 5:1. Generally L= 30 m (common) maximum 100 m. Breadth= 6 m to 10 m. Circular: Diameter not greater than 60 m. generally 20 to 40 m.
4. Depth 2.5 to 5.0 m (3 m).
5. Surface Overflow Rate: For plain sedimentation 12000 to 18000 L/d/m<sup>2</sup> tank area; for thoroughly flocculated water 24000 to 30000 L/d/m<sup>2</sup> tank area.
6. Slopes: Rectangular 1% towards inlet and circular 8%.

### **Sedimentation Tank Design**

**Problem:** Design a rectangular sedimentation tank to treat 2.4 million litres of raw water per day. The detention period may be assumed to be 3 hours.

**Solution:** Raw water flow per day is  $2.4 \times 10^6$  l. Detention period is 3h.

Volume of tank = Flow x Detention period =  $2.4 \times 10^3 \times 3/24 = 300 \text{ m}^3$

Assume depth of tank = 3.0 m.

Surface area =  $300/3 = 100 \text{ m}^2$

L/B = 3 (assumed). L = 3B.

$3B^2 = 100 \text{ m}^2$  i.e. B = 5.8 m

L = 3B = 5.8 X 3 = 17.4 m

Hence surface loading (Overflow rate) =  $\frac{2.4 \times 10^6}{100} = 24,000 \text{ l/d/m}^2 < 40,000 \text{ l/d/m}^2$  (OK)

## **LECTURE-9**

### **General Properties of Colloids**

1. Colloidal particles are so small that their **surface area** in relation to mass is very large.
2. **Electrical properties:** All colloidal particles are electrically charged. If electrodes from a D.C. source are placed in a colloidal dispersion, the particles migrate towards the pole of opposite charge.
3. Colloidal particles are in constant motion because of bombardment by molecules of dispersion medium. This motion is called **Brownian motion** (named after Robert Brown who first noticed it).
4. **Tyndall effect:** Colloidal particles have dimensionThese are reversible upon heating. e.g. organics in water.
5. **Adsorption:** Colloids have high surface area and hence have a lot of active surface for adsorption to occur. The stability of colloids is mainly due to preferential adsorption of ions. There are two types of colloids:
  - i. **Lyophobic colloids:** that are solvent hating. These are irreversible upon heating. e.g. inorganic colloids, metal halides.
  - ii. **Lyophilic colloids:** that are solvent loving. These are reversible upon heating. e.g. organics in water.

### **Coagulation and Flocculation**

- Colloidal particles are difficult to separate from water because they do not settle by gravity and are so small that they pass through the pores of filtration media.
- To be removed, the individual colloids must aggregate and grow in size.
- The aggregation of colloidal particles can be considered as involving two separate and distinct steps:
  1. Particle transport to effect interparticle collision.
  2. Particle destabilization to permit attachment when contact occurs.

Transport step is known as **flocculation** whereas **coagulation** is the overall process involving destabilization and transport.

### **Electrical Double Layer**

Although individual hydrophobic colloids have an electrical charge, a colloidal dispersion does not have a net electrical charge. The diffuse layer in a colloidal dispersion contains a quantity of counter ions sufficient to balance the electrical charge on the particle. The charge distribution in the diffuse layer of a negatively charged colloid can be represented by the curve ABCD in the figure. The ions involved in this electroneutrality are arranged in such a way as to constitute what is called **electrical double layer**.

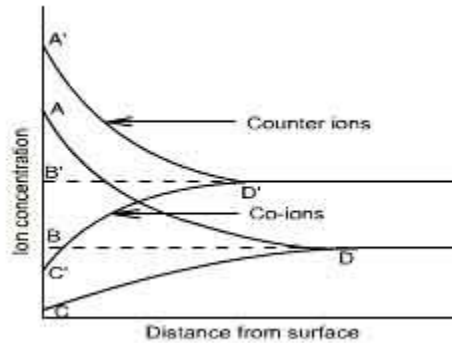

Net repulsion force, which may be considered as energy barrier must be overcome before aggregation occurs. The magnitude of energy barrier depends on (1) charge on the particle, and (2) ionic composition of water.

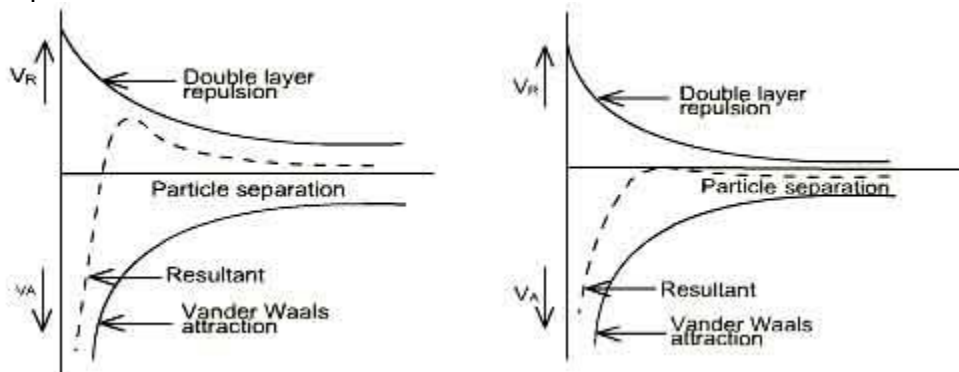

### **Destabilization of Colloidal Dispersion**

Particle destabilization can be achieved by four mechanisms:

- Change characteristics of medium-*Compression of double layer.*
- Change characteristics of colloid particles-*Adsorption and charge neutralization.*
- Provide bridges-
  1. *Enmeshment in a precipitate.*
  2. *Adsorption and interparticle bridging.*

### **Flocculation**

Flocculation is stimulation by mechanical means to agglomerate destabilised particles into compact, fast settleable particles (or flocs). Flocculation or gentle agitation results from velocity

differences or gradients in the coagulated water, which causes the fine moving, destabilized particles to come into contact and become large, readily settleable flocs. It is a common practice to provide an initial rapid (or) flash mix for the dispersal of the coagulant or other chemicals into the water. Slow mixing is then done, during which the growth of the floc takes place.

**Rapid or Flash mixing** is the process by which a coagulant is rapidly and uniformly dispersed through the mass of water. This process usually occurs in a small basin immediately preceding or at the head of the coagulation basin. Generally, the detention period is 30 to 60 seconds and the head loss is 20 to 60 cms of water. Here colloids are destabilised and the nucleus for the floc is formed.

**Slow mixing** brings the contacts between the finely divided destabilised matter formed during rapid mixing.

### **Perikinetic and Orthokinetic Flocculation**

The flocculation process can be broadly classified into two types, perikinetic and orthokinetic.

Perikinetic flocculation refers to flocculation (contact or collisions of colloidal particles) due to Brownian motion of colloidal particles. The random motion of colloidal particles results from their rapid and random bombardment by the molecules of the fluid.

Orthokinetic flocculation refers to contacts or collisions of colloidal particles resulting from bulk fluid motion, such as stirring. In systems of stirring, the velocity of the fluid varies both spatially (from point to point) and temporally (from time to time). The spatial changes in velocity are identified by a velocity gradient,  $G$ .  $G$  is estimated as  $G=(P/\mu V)^{1/2}$ , where  $P$ =Power,  $V$ =channel volume, and  $\mu$ = Absolute viscosity.

### **Mechanism of Flocculation**

*Gravitational flocculation:* Baffle type mixing basins are examples of gravitational flocculation. Water flows by gravity and baffles are provided in the basins which induce the required velocity gradients for achieving floc formation.

*Mechanical flocculation:* Mechanical flocculator consists of revolving paddles with horizontal or vertical shafts or paddles suspended from horizontal oscillating beams, moving up and down.

### **Coagulation in Water Treatment**

- Salts of Al(III) and Fe(III) are commonly used as coagulants in water and wastewater treatment.
- When a salt of Al(III) and Fe(III) is added to water, it dissociates to yield trivalent ions, which hydrate to form aquometal complexes  $Al(H_2O)_6^{3+}$  and  $Fe(H_2O)_6^{3+}$ . These complexes then pass through a series of hydrolytic reactions in which  $H_2O$  molecules in the hydration shell are replaced by  $OH^-$  ions to form a variety of soluble species such as  $Al(OH)^{2+}$  and  $Al(OH)^{2+}$ . These products are quite effective as coagulants as they adsorb very strongly onto the surface of most negative colloids.

### **Destabilization using Al(III) and Fe(III) Salts**

- Al(III) and Fe(III) accomplish destabilization by two mechanisms: (1) Adsorption and charge neutralization. (2) Enmeshment in a sweep floc.
- Interrelations between pH, coagulant dosage, and colloid concentration determine mechanism responsible for coagulation.
- Charge on hydrolysis products and precipitation of metal hydroxides are both controlled by pH. The hydrolysis products possess a positive charge at pH values below iso-electric point of the metal hydroxide. Negatively charged species which predominate above iso-electric point, are ineffective for the destabilization of negatively charged colloids.
- Precipitation of amorphous metal hydroxide is necessary for sweep-floc coagulation.
- The solubility of Al(OH)<sub>3</sub>(s) and Fe(OH)<sub>3</sub>(s) is minimal at a particular pH and increases as the pH increases or decreases from that value. Thus, pH must be controlled to establish optimum conditions for coagulation.
- Alum and Ferric Chloride reacts with natural alkalinity in water as follows:  

$$\text{Al}_2(\text{SO}_4)_3 \cdot 14\text{H}_2\text{O} + 6\text{HCO}_3^- \longrightarrow 2\text{Al}(\text{OH})_3(\text{s}) + 6\text{CO}_2 + 14\text{H}_2\text{O} + 3\text{SO}_4^{2-}$$
- $\text{FeCl}_3 + 3\text{HCO}_3^- \longrightarrow \text{Fe}(\text{OH})_3(\text{s}) + 3\text{CO}_2 + 3\text{Cl}^-$

### **Jar Test**

The jar test is a common laboratory procedure used to determine the optimum operating conditions for water or wastewater treatment. This method allows adjustments in pH, variations in coagulant or polymer dose, alternating mixing speeds, or testing of different coagulant or polymer types, on a small scale in order to predict the functioning of a large scale treatment operation.

### **Jar Testing Apparatus**

The jar testing apparatus consists of six paddles which stir the contents of six 1 liter containers. One container acts as a control while the operating conditions can be varied among the remaining five containers. A rpm gage at the top-center of the device allows for the uniform control of the mixing speed in all of the containers.

### **Jar Test Procedure**

- The jar test procedures involves the following steps:
- Fill the jar testing apparatus containers with sample water. One container will be used as a control while the other 5 containers can be adjusted depending on what conditions are being tested. For example, the pH of the jars can be adjusted or variations of coagulant dosages can be added to determine optimum operating conditions.
- Add the coagulant to each container and stir at approximately 100 rpm for 1 minute. The rapid mix stage helps to disperse the coagulant throughout each container.
- Turn off the mixers and allow the containers to settle for 30 to 45 minutes. Then measure the final turbidity in each container.
- Reduce the stirring speed to 25 to 35 rpm and continue mixing for 15 to 20 minutes. This slower mixing speed helps promote floc formation by enhancing particle collisions which lead to larger flocs.
- Residual turbidity vs. coagulant dose is then plotted and optimal conditions are determined. The values that are obtained through the experiment are correlated and adjusted in order to account for the actual treatment system.

## LECTURE-10

### Filtration

- The resultant water after sedimentation will not be pure, and may contain some very fine suspended particles and bacteria in it. To remove or to reduce the remaining impurities still further, the water is filtered through the beds of fine granular material, such as sand, etc. The process of passing the water through the beds of such granular materials is known as Filtration.

#### How Filters Work: Filtration Mechanisms

- There are four basic filtration mechanisms:
- **SEDIMENTATION** : The mechanism of sedimentation is due to force of gravity and the associate settling velocity of the particle, which causes it to cross the streamlines and reach the collector.
- **INTERCEPTION** : Interception of particles is common for large particles. If a large enough particle follows the streamline, that lies very close to the media surface it will hit the media grain and be captured.
- **BROWNIAN DIFFUSION** : Diffusion towards media granules occurs for very small particles, such as viruses. Particles move randomly about within the fluid, due to thermal gradients. This mechanism is only important for particles with diameters  $< 1$  micron.
- **INERTIA** : Attachment by inertia occurs when larger particles move fast enough to travel off their streamlines and bump into media grains.

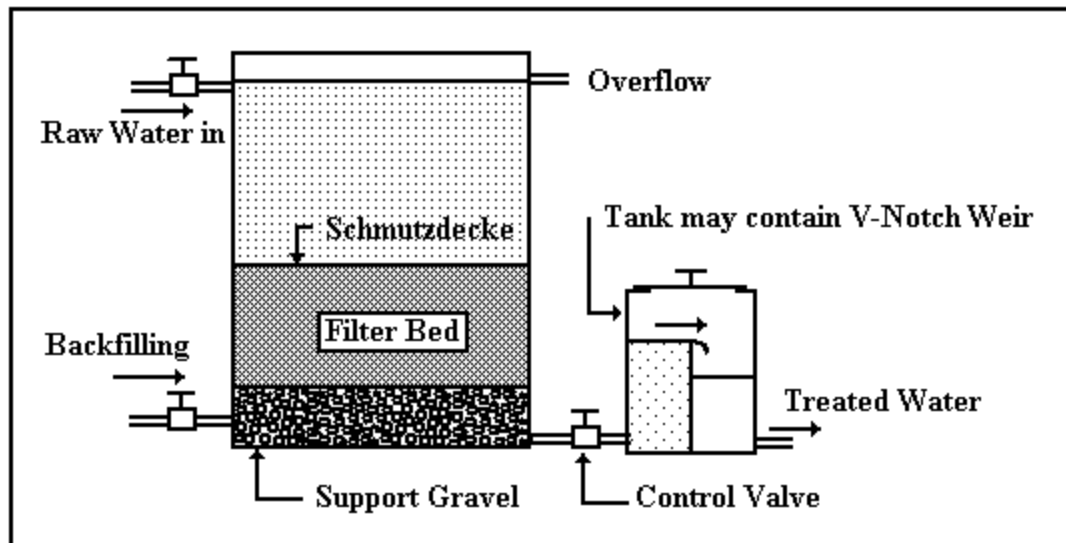

### Filter Materials

**Sand:** Sand, either fine or coarse, is generally used as filter media. The size of the sand is measured and expressed by the term called effective size. The effective size, i.e.  $D_{10}$  may be defined as the size of the sieve in mm through which ten percent of the sample of sand by weight will pass. The uniformity in size or degree of variations in sizes of particles is measured and expressed by the term called uniformity coefficient. The uniformity coefficient, i.e.  $(D_{60}/D_{10})$

may be defined as the ratio of the sieve size in mm through which 60 percent of the sample of sand will pass, to the effective size of the sand.

**Gravel:** The layers of sand may be supported on gravel, which permits the filtered water to move freely to the under drains, and allows the wash water to move uniformly upwards.

**Other materials:** Instead of using sand, sometimes, anthrafil is used as filter media. Anthrafil is made from anthracite, which is a type of coal-stone that burns without smoke or flames. It is cheaper and has been able to give a high rate of filtration.

### Types of Filter

**Slow sand filter:** They consist of fine sand, supported by gravel. They capture particles near the surface of the bed and are usually cleaned by scraping away the top layer of sand that contains the particles.

**Rapid-sand filter:** They consist of larger sand grains supported by gravel and capture particles throughout the bed. They are cleaned by backwashing water through the bed to 'lift out' the particles.

**Multimedia filters:** They consist of two or more layers of different granular materials, with different densities. Usually, anthracite coal, sand, and gravel are used. The different layers combined may provide more versatile collection than a single sand layer. Because of the differences in densities, the layers stay neatly separated, even after backwashing.

### Principles of Slow Sand Filtration

- In a slow sand filter impurities in the water are removed by a combination of processes: sedimentation, straining, adsorption, and chemical and bacteriological action.
- During the first few days, water is purified mainly by mechanical and physical-chemical processes. The resulting accumulation of sediment and organic matter forms a thin layer on the sand surface, which remains permeable and retains particles even smaller than the spaces between the sand grains.
- As this layer (referred to as "Schmutzdecke") develops, it becomes living quarters of vast numbers of micro-organisms which break down organic material retained from the water, converting it into water, carbon dioxide and other oxides.
- Most impurities, including bacteria and viruses, are removed from the raw water as it passes through the filter skin and the layer of filter bed sand just below. The purification mechanisms extend from the filter skin to approx. 0.3-0.4 m below the surface of the filter bed, gradually decreasing in activity at lower levels as the water becomes purified and contains less organic material.
- When the micro-organisms become well established, the filter will work efficiently and produce high quality effluent which is virtually free of disease carrying organisms and biodegradable organic matter.
- They are suitable for treating waters with low colors, low turbidities and low bacterial contents.

### Sand Filters vs. Rapid Sand Filters

- **Base material:** In SSF it varies from 3 to 65 mm in size and 30 to 75 cm in depth while in RSF it varies from 3 to 40 mm in size and its depth is slightly more, i.e. about 60 to 90 cm.
- **Filter sand:** In SSF the effective size ranges between 0.2 to 0.4 mm and uniformity coefficient between 1.8 to 2.5 or 3.0. In RSF the effective size ranges between 0.35 to 0.55 and uniformity coefficient between 1.2 to 1.8.
- **Rate of filtration:** In SSF it is small, such as 100 to 200 L/h/sq.m. of filter area while in RSF it is large, such as 3000 to 6000 L/h/sq.m. of filter area.
- **Flexibility:** SSF are not flexible for meeting variation in demand whereas RSF are quite flexible for meeting reasonable variations in demand.
- **Post treatment required:** Almost pure water is obtained from SSF. However, water may be disinfected slightly to make it completely safe. Disinfection is a must after RSF.
- **Method of cleaning:** Scrapping and removing of the top 1.5 to 3 cm thick layer is done to clean SSF. To clean RSF, sand is agitated and backwashed with or without compressed air.
- **Loss of head:** In case of SSF approx. 10 cm is the initial loss, and 0.8 to 1.2m is the final limit when cleaning is required. For RSF 0.3m is the initial loss, and 2.5 to 3.5m is the final limit when cleaning is required.

### Clean Water Headloss

Several equations have been developed to describe the flow of clean water through a porous medium. Carman-Kozeny equation used to calculate head loss is as follows:

$$h = \frac{f(1-n)Lv_s^2}{\Phi n^3 d_g}$$

$$f = 150 \frac{(1-n)}{N_g} + 1.75$$

where, h = headloss, m

f = friction factor

n = porosity

$\Phi$  = particle shape factor (1.0 for spheres, 0.82 for rounded sand, 0.75 for average sand, 0.73 for crushed coal and angular sand)

L = depth of filter bed or layer, m

d = grain size diameter, m

$v_s$  = superficial (approach) filtration velocity, m/s

g = acceleration due to gravity, 9.81 m/s<sup>2</sup>

p = fraction of particles ( based on mass) within adjacent sieve sizes

$d_g$  = geometric mean diameter between sieve sizes  $d_1$  and  $d_2$

$N_g$  = Reynolds number

$\mu$  = viscosity, N-s/m<sup>2</sup>

### Backwashing of Rapid Sand Filter

- For a filter to operate efficiently, it must be cleaned before the next filter run. If the water applied to a filter is of very good quality, the filter runs can be very long. Some filters can operate longer than one week before needing to be backwashed. However, this is not recommended as long filter runs can cause the filter media to pack down so that it is difficult to expand the bed during the backwash.

- Treated water from storage is used for the backwash cycle. This treated water is generally taken from elevated storage tanks or pumped in from the clear well.
- The filter backwash rate has to be great enough to expand and agitate the filter media and suspend the floc in the water for removal. However, if the filter backwash rate is too high, media will be washed from the filter into the troughs and out of the filter.

### **When is Backwashing Needed**

The filter should be backwashed when the following conditions have been met:

- The head loss is so high that the filter no longer produces water at the desired rate; and/or Floc starts to break through the filter and the turbidity in the filter effluent increases; and/or A filter run reaches a given hour of operation.

## **LECTURE-11**

### **Operational Troubles in Rapid Gravity Filters**

#### ***Air Binding:***

- When the filter is newly commissioned, the loss of head of water percolating through the filter is generally very small. However, the loss of head goes on increasing as more and more impurities get trapped into it.
- A stage is finally reached when the frictional resistance offered by the filter media exceeds the static head of water above the and bed. Most of this resistance is offered by the top 10 to 15 cm sand layer. The bottom sand acts like a vacuum, and water is sucked through the filter media rather than getting filtered through it.
- The negative pressure so developed, tends to release the dissolved air and other gases present in water. The formation of bubbles takes place which stick to the sand grains. This phenomenon is known as Air Binding as the air binds the filter and stops its functioning.
- To avoid such troubles, the filters are cleaned as soon as the head loss exceeds the optimum allowable value.

#### ***Formation of Mud Balls:***

- The mud from the atmosphere usually accumulates on the sand surface to form a dense mat. During inadequate washing this mud may sink down into the sand bed and stick to the sand grains and other arrested impurities, thereby forming mud balls.

#### ***Cracking of Filters:***

- The fine sand contained in the top layers of the filter bed shrinks and causes the development of shrinkage cracks in the sand bed. With the use of filter, the loss of head and, therefore, pressure on the sand bed goes on increasing, which further goes on widening these cracks.

### **Remedial Measures to Prevent Cracking of Filters and Formation of Mud Balls**



- Breaking the top fine mud layer with rakes and washing off the particles.
- Washing the filter with a solution of caustic soda.
- Removing, cleaning and replacing the damaged filter sand.

**Standard design practice of Rapid Sand filter:** Maximum length of lateral = not less than 60 times its diameter. Spacing of holes = 6 mm holes at 7.5 cm c/c or 13 at 15 c/c. C.S area of lateral = not less than 2 times area of perforations. C.S area of manifold = 2 times total area of laterals. Maximum loss of head = 2 to 5 m. Spacing of laterals = 15 to 30 cm c/c. Pressure of wash water at perforations = not greater than 1.05 kg/cm<sup>2</sup>. Velocity of flow in lateral = 2 m/s. Velocity of flow in manifold = 2.25 m/s. Velocity of flow in manifold for washwater = 1.8 to 2.5 m/s. Velocity of rising washwater = 0.5 to 1.0 m/min. Amount of washwater = 0.2 to 0.4% of total filtered water. Time of backwashing = 10 to 15 min. Head of water over the filter = 1.5 to 2.5 m. Free board = 60 cm. Bottom slope = 1 to 60 towards manifold.

$$Q = (1.71 \times b \times h^{3/2})$$

where Q is in m<sup>3</sup>/s, b is in m, h is in m. L:B = 1.25 to 1.33:1 .

### **Rapid Sand Filter Design**

**Problem:** Design a rapid sand filter to treat 10 million litres of raw water per day allowing 0.5% of filtered water for backwashing. Half hour per day is used for bakwashing. Assume necessary data.

**Solution:** Total filtered water =  $\frac{10.05 \times 24 \times 10^6}{24 \times 23.5} = 0.42766 \text{ MI / h}$

Let the rate of filtration be 5000 l / h / m<sup>2</sup> of bed.

$$\text{Area of filter} = \frac{10.05 \times 10^6}{23.5} \times \frac{1}{5000} = 85.5 \text{ m}^2$$

Provide two units. Each bed area 85.5/2 = 42.77. L/B = 1.3; 1.3B<sup>2</sup> = 42.77

B = 5.75 m ; L = 5.75 x 1.3 = 7.5 m

Assume depth of sand = 50 to 75 cm.

**Underdrainage system:**

Total area of holes = 0.2 to 0.5% of bed area.

$$\text{Assume 0.2% of bed area} = \frac{0.2}{100} \times 42.77 = 0.086 \text{ m}^2$$

Area of lateral = 2 (Area of holes of lateral)

Area of manifold = 2 (Area of laterals)

So, area of manifold = 4 x area of holes = 4 x 0.086 = 0.344 = 0.35 m<sup>2</sup> .

Diameter of manifold =  $(4 \times 0.35 / \pi)^{1/2} = 66 \text{ cm}$

Assume c/c of lateral = 30 cm. Total numbers = 7.5/ 0.3 = 25 on either side.

Length of lateral = 5.75/2 - 0.66/2 = 2.545 m.

C.S. area of lateral = 2 x area of perforations per lateral. Take dia of holes = 13 mm

$$\text{Number of holes: } n_{\pi} (1.3)^2 = 0.086 \times 10^4 = 860 \text{ cm}^2$$

$$n = \frac{4 \times 860}{\pi (1.3)^2} = 648, \text{ say } 650$$

Number of holes per lateral = 650/50 = 13

Area of perforations per lateral = 13 x  $\pi (1.3)^2 / 4 = 17.24 \text{ cm}^2$

Spacing of holes =  $2.545/13 = 19.5$  cm.

C.S. area of lateral =  $2 \times \text{area of perforations per lateral} = 2 \times 17.24 = 34.5$  cm<sup>2</sup>.

Diameter of lateral =  $(4 \times 34.5 / \pi)^{1/2} = 6.63$  cm

Check: Length of lateral <  $60d = 60 \times 6.63 = 3.98$  m.  $l = 2.545$  m (Hence acceptable).

Rising washwater velocity in bed = 50 cm/min.

Washwater discharge per bed =  $(0.5/60) \times 5.75 \times 7.5 = 0.36$  m<sup>3</sup>/s.

Velocity of flow through lateral =  $\frac{0.36}{\text{Total lateral area}} = \frac{0.36 \times 10^4}{50 \times 34.5} = 2.08$  m/s (ok)

Manifold velocity =  $\frac{0.36}{0.345} = 1.04$  m/s < 2.25 m/s (ok)

#### Washwater gutter

Discharge of washwater per bed = 0.36 m<sup>3</sup>/s. Size of bed = 7.5 x 5.75 m.

Assume 3 troughs running lengthwise at  $5.75/3 = 1.9$  m c/c.

Discharge of each trough =  $Q/3 = 0.36/3 = 0.12$  m<sup>3</sup>/s.

$$Q = 1.71 \times b \times h^{3/2}$$

Assume  $b = 0.3$  m

$$h^{3/2} = \frac{0.12}{1.71 \times 0.3} = 0.234$$

$$h = 0.378 \text{ m} = 37.8 \text{ cm} = 40 \text{ cm}$$

$$= 40 + (\text{free board}) 5 \text{ cm} = 45 \text{ cm}; \text{ slope } 1 \text{ in } 40$$

#### Clear water reservoir for backwashing

For 4 h filter capacity, Capacity of tank =  $\frac{4 \times 5000 \times 7.5 \times 5.75 \times 2}{1000} = 1725$  m<sup>3</sup>

Assume depth  $d = 5$  m. Surface area =  $1725/5 = 345$  m<sup>2</sup>

$L/B = 2$ ;  $2B^2 = 345$ ;  $B = 13$  m &  $L = 26$  m.

Dia of inlet pipe coming from two filter = 50 cm.

Velocity < 0.6 m/s. Diameter of washwater pipe to overhead tank = 67.5 cm.

Air compressor unit = 1000 l of air/ min/ m<sup>2</sup> bed area.

For 5 min, air required =  $1000 \times 5 \times 7.5 \times 5.77 \times 2 = 4.32$  m<sup>3</sup> of air.

## LECTURE-12

### Disinfection

The filtered water may normally contain some harmful disease producing bacteria in it. These bacteria must be killed in order to make the water safe for drinking. The process of killing these bacteria is known as Disinfection or Sterilization.

### Disinfection Kinetics

When a single unit of microorganisms is exposed to a single unit of disinfectant, the reduction in microorganisms follows a first-order reaction.

$$dN/dt = -kN \quad N = N_0 e^{-kt}$$

This equation is known as Chick's Law:-

$N$  = number of microorganism ( $N_0$  is initial number)

$k$  = disinfection constant

$t$  = contact time

### Methods of Disinfection

1. **Boiling:** The bacteria present in water can be destroyed by boiling it for a long time. However it is not practically possible to boil huge amounts of water. Moreover it cannot take care of future possible contaminations.
2. **Treatment with Excess Lime:** Lime is used in water treatment plant for softening. But if excess lime is added to the water, it can in addition, kill the bacteria also. Lime when added raises the pH value of water making it extremely alkaline. This extreme alkalinity has been found detrimental to the survival of bacteria. This method needs the removal of excess lime from the water before it can be supplied to the general public. Treatment like recarbonation for lime removal should be used after disinfection.
3. **Treatment with Ozone:** Ozone readily breaks down into normal oxygen, and releases nascent oxygen. The nascent oxygen is a powerful oxidising agent and removes the organic matter as well as the bacteria from the water.
4. **Chlorination:** The germicidal action of chlorine is explained by the recent theory of *Enzymatic hypothesis*, according to which the chlorine enters the cell walls of bacteria and kill the enzymes which are essential for the metabolic processes of living organisms.

### Chlorine Chemistry

Chlorine is added to the water supply in two ways. It is most often added as a gas,  $\text{Cl}_2(\text{g})$ . However, it also can be added as a salt, such as sodium hypochlorite ( $\text{NaOCl}$ ) or bleach. Chlorine gas dissolves in water following Henry's Law.

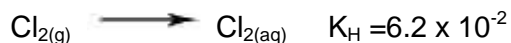

Once dissolved, the following reaction occurs forming hypochlorous acid ( $\text{HOCl}$ ):



Hypochlorous acid is a weak acid that dissociates to form hypochlorite ion ( $\text{OCl}^-$ ).

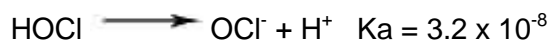

All forms of chlorine are measured as mg/L of  $\text{Cl}_2$  ( $\text{MW} = 2 \times 35.45 = 70.9 \text{ g/mol}$ ) Hypochlorous acid and hypochlorite ion compose what is called the free chlorine residual. These free chlorine compounds can react with many organic and inorganic compounds to form chlorinated compounds. If the products of these reactions possess oxidizing potential, they are considered the combined chlorine residual. A common compound in drinking water systems that reacts with chlorine to form combined residual is ammonia. Reactions between ammonia and chlorine form chloramines, which is mainly monochloramine ( $\text{NH}_2\text{Cl}$ ), although some dichloramine ( $\text{NHCl}_2$ ) and trichloramine ( $\text{NCl}_3$ ) also can form. Many drinking water utilities use monochloramine as a disinfectant. If excess free chlorine exists once all ammonia nitrogen has been converted to monochloramine, chloramine species are oxidized through what is termed the breakpoint reactions. The overall reactions of free chlorine and nitrogen can be represented by two simplified reactions as follows:

Monochloramine Formation Reaction. This reaction occurs rapidly when ammonia nitrogen is combined with free chlorine up to a molar ratio of 1:1.



**Breakpoint Reaction:** When excess free chlorine is added beyond the 1:1 initial molar ratio, monochloramine is removed as follows:



The formation of chloramines and the breakpoint reaction create a unique relationship between chlorine dose and the amount and form of chlorine as illustrated below.

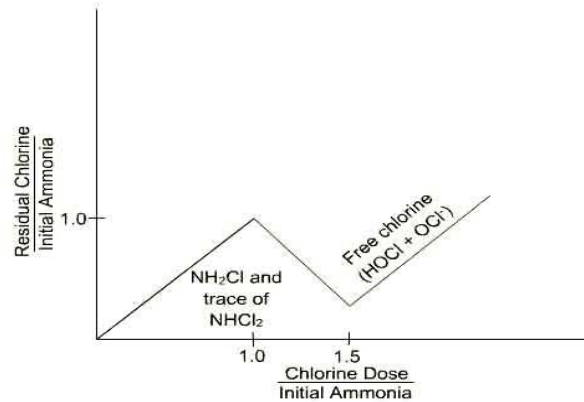

### Free Chlorine, Chloramine, and Ammonia Nitrogen Reactions

#### Chlorine Demand

Free chlorine and chloramines readily react with a variety of compounds, including organic substances, and inorganic substances like iron and manganese. The stoichiometry of chlorine reactions with organics can be represented as shown below:

#### **HOCl:**

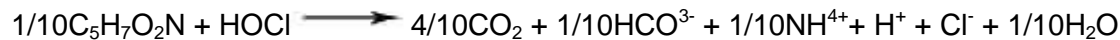

#### **OCl<sup>-</sup>:**

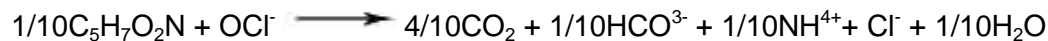

#### **NH<sub>2</sub>Cl:**



Chlorine demand can be increased by oxidation reactions with inorganics, such as reduced iron at corrosion sites at the pipe wall. Possible reactions with all forms of chlorine and iron are as follows:

#### Treatment Plant Layout and Siting

**Plant layout** is the arrangement of designed treatment units on the selected site. **Siting** is the selection of site for treatment plant based on features such as character, topography, and shoreline. Site development should take the advantage of the existing site topography. The following principles are important to consider:

1. A site on a side-hill can facilitate gravity flow that will reduce pumping requirements and locate normal sequence of units without excessive excavation or fill.

2. When landscaping is utilized it should reflect the character of the surrounding area. Site development should alter existing naturally stabilized site contours and drainage as little as possible.
3. The developed site should be compatible with the existing land uses and the comprehensive development plan.

## **LECTURE-13**

### **Treatment Plant Hydraulics**

**Hydraulic profile** is the graphical representation of the hydraulic grade line through the treatment plant. The head loss computations are started in the direction of flow using water surface in the influent of first treatment unit as the reference level. The **total available head** at the treatment plant is the difference in water surface elevations in the influent of first treatment unit and that in the effluent of last treatment unit. If the total available head is less than the head loss through the plant, flow by gravity cannot be achieved. In such cases pumping is needed to raise the head so that flow by gravity can occur.

There are many basic principles that must be considered when preparing the hydraulic profile through the plant. Some are listed below:

1. The hydraulic profiles are prepared at peak and average design flows and at minimum initial flow.
2. The hydraulic profile is generally prepared for all main paths of flow through the plant.
3. The head loss through the treatment plant is the sum of head losses in the treatment units and the connecting piping and appurtenances.
4. The head losses through the treatment unit include the following:
  - a. Head losses at the influent structure.
  - b. Head losses at the effluent structure.
  - c. Head losses through the unit.
  - d. Miscellaneous and free fall surface allowance.
5. The total loss through the connecting pipings, channels and appurtenances is the sum of following:
  - a. Head loss due to entrance.
  - b. Head loss due to exit.
  - c. Head loss due to contraction and enlargement.
  - d. Head loss due to friction.
  - e. Head loss due to bends, fittings, gates, valves, and meters.
  - f. Head required over weir and other hydraulic controls.
  - g. Free-fall surface allowance.

## LECTURE-14

### Module III

#### Wastewater Quantity Estimation

The flow of sanitary sewage alone in the absence of storms in dry season is known as dry weather flow (DWF).

**Quantity= Per capita sewage contributed per day x Population**

Sanitary sewage is mostly the spent water of the community draining into the sewer system. It has been observed that a small portion of spent water is lost in evaporation, seepage in ground, leakage, etc. Usually 80% of the water supply may be expected to reach the sewers.

#### Fluctuations in Dry Weather Flow

Since dry weather flow depends on the quantity of water used, and as there are fluctuations in rate of water consumption, there will be fluctuations in dry weather flow also. In general, it can be assumed that (i) Maximum daily flow = 2 x average daily flow and (ii) Minimum daily flow = 2/3 x (average daily flow).

#### Population Equivalent

Population equivalent is a parameter used in the conversion of contribution of wastes from industrial establishments for accepting into sanitary sewer systems. The strength of industrial sewage is, thus, written as

Std. BOD<sub>5</sub> = (Std. BOD<sub>5</sub> of domestic sewage per person per day) x (population equivalent)

#### Design Periods & Population Forecast

This quantity should be worked out with due provision for the estimated requirements of the future. The future period for which a provision is made in the water supply scheme is known as the **design period**. It is suggested that the construction of sewage treatment plant may be carried out in phases with an initial design period ranging from 5 to 10 years excluding the construction period.

Design period is estimated based on the following:

- Useful life of the component, considering obsolescence, wear, tears, etc.
- Expandability aspect.
- Anticipated rate of growth of population, including industrial, commercial developments & migration-immigration.
- Available resources.
- Performance of the system during initial period.

### **Population forecasting methods:**

The various methods adopted for estimating future populations are given below. The particular method to be adopted for a particular case or for a particular city depends largely on the factors discussed in the methods, and the selection is left to the discretion and intelligence of the designer.

1. *Arithmetic Increase Method*
2. *Geometric Increase Method*
3. *Incremental Increase Method*
4. *Decreasing Rate of Growth Method*
5. *Simple Graphical Method*
6. *Comparative Graphical Method*
7. *Ratio Method*
8. *Logistic Curve Method*

### **Wastewater Characterization**

To design a treatment process properly, characterization of wastewater is perhaps the most critical step. Wastewater characteristics of importance in the design of the activated sludge process can be grouped into the following categories:

Temperature  
 pH  
 Colour and Odour  
 Carbonaceous substrates  
 Nitrogen  
 Phosphorous  
 Chlorides  
 Total and volatile suspended solids (TSS and VSS)  
 Toxic metals and compounds

## **LECTURE-15**

### **Design of Sewers**

The hydraulic design of sewers and drains, which means finding out their sections and gradients, is generally carried out on the same lines as that of the water supply pipes. However,

there are two major differences between characteristics of flows in sewers and water supply pipes. They are:

- The sewage contain particles in suspension, the heavier of which may settle down at the bottom of the sewers, as and when the flow velocity reduces, resulting in the clogging of sewers. To avoid silting of sewers, it is necessary that the sewer pipes be laid at such a gradient, as to generate self cleansing velocities at different possible discharges.
- The sewer pipes carry sewage as gravity conduits, and are therefore laid at a continuous gradient in the downward direction upto the outfall point, from where it will be lifted up, treated and disposed of.

Hazen-William's formula;  $U=0.85 C r_H^{0.63} S^{0.54}$

Manning's formula:  $U=1/n r_H^{2/3} S^{1/2}$

where, U= velocity, m/s;  $r_H$ = hydraulic radius,m; S= slope, C= Hazen-William's coefficient, and n = Manning's coefficient.

Darcy-Weisbach formula:  $h_L=(fLU^2)/(2gd)$

### **Minimum Velocity**

The flow velocity in the sewers should be such that the suspended materials in sewage do not get silted up; i.e. the velocity should be such as to cause automatic self-cleansing effect. The generation of such a minimum *self cleansing velocity* in the sewer, atleast once a day, is important, because if certain deposition takes place and is not removed, it will obstruct free flow, causing further deposition and finally leading to the complete blocking of the sewer.

### **Maximum Velocity**

The smooth interior surface of a sewer pipe gets scoured due to continuous abrasion caused by the suspended solids present in sewage. It is, therefore, necessary to limit the maximum velocity in the sewer pipe. This limiting or non-scouring velocity will mainly depend upon the material of the sewer.

### **Effects of Flow Variation on Velocity in a Sewer**

Due to variation in discharge, the depth of flow varies, and hence the hydraulic mean depth (r) varies. Due to the change in the hydraulic mean depth, the flow velocity (which depends directly on  $r^{2/3}$ ) gets affected from time to time. It is necessary to check the sewer for maintaining a minimum velocity of about 0.45 m/s at the time of minimum flow (assumed to be 1/3<sup>rd</sup> of average flow). The designer should also ensure that a velocity of 0.9 m/s is developed atleast at the time of maximum flow and preferably during the average flow periods also. Moreover, care should be taken to see that at the time of maximum flow, the velocity generated does not exceed the scouring value.



## **Sewer Appurtenances**

Sewer appurtenances are the various accessories on the sewerage system and are necessary for the efficient operation of the system. They include man holes, lamp holes, street inlets, catch basins, inverted siphons, and so on.

**Man-holes:** Man holes are the openings of either circular or rectangular in shape constructed on the alignment of a sewer line to enable a person to enter the sewer for inspection, cleaning and flushing. They serve as ventilators for sewers, by the provisions of perforated man-hole covers. Also they facilitate the laying of sewer lines in convenient length.

Man-holes are provided at all junctions of two or more sewers, whenever diameter of sewer changes, whenever direction of sewer line changes and when sewers of different elevations join together.

### **Special Man-holes:**

**Junction chambers:** Man-hole constructed at the intersection of two large sewers.

**Drop man-hole:** When the difference in elevation of the invert levels of the incoming and outgoing sewers of the man-hole is more than 60 cm, the interception is made by dropping the incoming sewer vertically outside and then it is jointed to the man-hole chamber.

**Flushing man-holes:** They are located at the head of a sewer to flush out the deposits in the sewer with water.

**Lamp-holes:** Lamp holes are the openings constructed on the straight sewer lines between two man-holes which are far apart and permit the insertion of a lamp into the sewer to find out obstructions if any inside the sewers from the next man-hole.

**Street inlets:** Street inlets are the openings through which storm water is admitted and conveyed to the storm sewer or combined sewer. The inlets are located by the sides of pavement with maximum spacing of 30 m.

**Catch Basins:** Catch basins are small settling chambers of diameter 60 - 90 cm and 60 - 75 cm deep, which are constructed below the street inlets. They interrupt the velocity of storm water entering through the inlets and allow grit, sand, debris and so on to settle in the basin, instead of allowing them to enter into the sewers.

**Inverted siphons:** These are depressed portions of sewers, which flow full under pressure more than the atmospheric pressure due to flow line being below the hydraulic grade line. They are constructed when a sewer crosses a stream or deep cut or road or railway line. To clean the siphon pipe sluice valve is opened, thus increasing the head causing flow. Due to increased velocity deposits of siphon pipe are washed into the sump, from where they are removed.

## Pumping of Sewage

Pumping of sewage is required when it is not possible to have a gravitational flow for the entire sewerage project.

Sufficient pumping capacity has to be provided to meet the peak flow, atleast 50% as stand by.

### Types of pumps :

1. Centrifugal pumps either axial, mixed and radial flow.
2. Pneumatic ejector pumps.

The raw sewage must be treated before it is discharged into the river stream. The extent of treatment required to be given depends not only upon the characteristics and quality of the sewage but also upon the source of disposal, its quality and capacity to tolerate the impurities present in the sewage effluents without itself getting potentially polluted. The layout of conventional wastewater treatment plant is as follows:

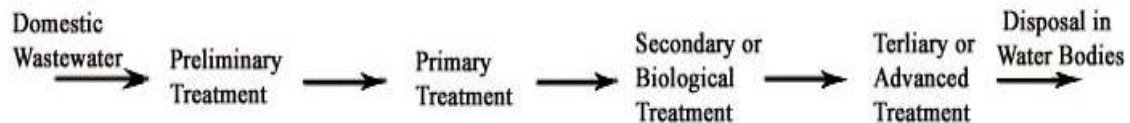

### Siting and Hydraulics of Wastewater Treatment Plant

Indian Standards for discharge of sewage in surface waters are given in the table below.

## LECTURE-16

### Indian Standards for Discharge of Sewage in Surface Waters

Characteristic of the Effluent	Tolerance <i>limit for Discharge of Sewage in Surface Water Sources</i>
BOD <sub>5</sub>	20 mg/L
TSS	30 mg/L

The unit operations and processes commonly employed in domestic wastewater treatment, their functions and units used to achieve these functions are given in the following table:

### Unit Operations/Processes, Their Functions and Units Used for Domestic Wastewater Treatment

Unit Operations/Processes	Functions	Treatment Devices
Screening	Removal of large floating, suspended and settleable solids	Bar racks and screens of various description
Grit Removal	Removal of inorganic suspended solids	Grit chamber
Primary Sedimentation	Removal of organic/inorganic settleable solids	Primary sedimentation tank
Aerobic Biological Suspended Growth Process	Conversion of colloidal, dissolved and residual suspended organic matter into settleable biofloc and stable inorganics	Activated sludge process units and its modifications, Waste stabilisation ponds, Aerated lagoons
Aerobic Biological Attached Growth Process	same as above	Trickling filter, Rotating biological contactor
Anaerobic biological growth processes	Conversion of organic matter into CH <sub>4</sub> & CO <sub>2</sub> and relatively stable organic residue	Anaerobic filter, Fluid bed submerged media anaerobic reactor, Upflow anaerobic sludge blanket reactor, Anaerobic rotating biological contactor
Anaerobic Stabilization of Organic Sludges	same as above	Anaerobic digester

## **Screening**

A screen is a device with openings for removing bigger suspended or floating matter in sewage which would otherwise damage equipment or interfere with satisfactory operation of treatment units.

### **Types of Screens**

**Coarse Screens:** Coarse screens also called racks, are usually bar screens, composed of vertical or inclined bars spaced at equal intervals across a channel through which sewage flows. Bar screens with relatively large openings of 75 to 150 mm are provided ahead of pumps, while those ahead of sedimentation tanks have smaller openings of 50 mm.

Bar screens are usually hand cleaned and sometimes provided with mechanical devices. These cleaning devices are rakes which periodically sweep the entire screen removing the solids for further processing or disposal. Hand cleaned racks are set usually at an angle of 45° to the horizontal to increase the effective cleaning surface and also facilitate the raking operations. Mechanical cleaned racks are generally erected almost vertically. Such bar screens have openings 25% in excess of the cross section of the sewage channel.

**Medium Screens:** Medium screens have clear openings of 20 to 50 mm. Bars are usually 10 mm thick on the upstream side and taper slightly to the downstream side. The bars used for screens are rectangular in cross section usually about 10 x 50 mm, placed with larger dimension parallel to the flow.

**Fine Screens:** Fine screens are mechanically cleaned devices using perforated plates, woven wire cloth or very closely spaced bars with clear openings of less than 20 mm. Fine screens are not normally suitable for sewage because of clogging possibilities.

The most commonly used bar type screen is shown in figure:

### Velocity

The velocity of flow ahead of and through the screen varies and affects its operation. The lower the velocity through the screen, the greater is the amount of screenings that would be removed from sewage. However, the lower the velocity, the greater would be the amount of solids deposited in the channel. Hence, the design velocity should be such as to permit 100% removal of material of certain size without undue depositions. Velocities of **0.6 to 1.2 mps through the open area for the peak flows** have been used satisfactorily. Further, the velocity at low flows in the approach channel should **not be less than 0.3 mps** to avoid deposition of solids.

### Head loss

Head loss varies with the quantity and nature of screenings allowed to accumulate between cleanings. The head loss created by a clean screen may be calculated by considering the flow and the effective areas of screen openings, the latter being the sum of the vertical projections of the openings. The head loss through clean flat bar screens is calculated from the following formula:

$$h = 0.0729 (V^2 - v^2)$$

where, h = head loss in m

V = velocity through the screen in mps

v = velocity before the screen in mps

Another formula often used to determine the head loss through a bar rack is Kirschmer's equation:

$$h = K(W/b)^{4/3} h_v \sin \theta$$

where h = head loss, m

$K$  = bar shape factor (2.42 for sharp edge rectangular bar, 1.83 for rectangular bar with semicircle upstream, 1.79 for circular bar and 1.67 for rectangular bar with both u/s and d/s face as semicircular).

$W$  = maximum width of bar u/s of flow, m

$b$  = minimum clear spacing between bars, m

$h_v$  = velocity head of flow approaching rack,  $m = v^2/2g$

$\theta$  = angle of inclination of rack with horizontal

The head loss through fine screen is given by

$$h = (1/2g) (Q/CA)$$

where,  $h$  = head loss, m

$Q$  = discharge,  $m^3/s$

$C$  = coefficient of discharge (typical value 0.6)

$A$  = effective submerged open area,  $m^2$

The quantity of screenings depends on the nature of the wastewater and the screen openings.

### Equalization Tanks

The equalization tanks are provided (i) to balance fluctuating flows or concentrations, (ii) to assist self neutralization, or (iii) to even out the effect of a periodic "slug" discharge from a batch process.

### Types of Equalization Tanks

Equalization tanks are generally of three types:

1. Flow through type
2. Intermittent flow type
3. Variable inflow/constant discharge type

The simple **flow through type** equalization tank is mainly useful in assisting self neutralization or evening out of fluctuating concentrations, not for balancing of flows since a flow through type tank once filled, gives output equal to input.

Flow balancing and self-neutralization are both achieved by using two tanks, intermittently one after another. One tank is allowed to fill up after which it is checked for pH (or any other parameter) and then allowed to empty out. The second tank goes through a similar routine. **Intermittent flow type** tanks are economic for small flows from industries.

When flows are large an equalization tank of such a size may have to be provided that **inflow can be variable while outflow is at a constant rate**, generally by a pump. The capacity required is determined from a plot of the cumulative inflow and a plot of the constant rate outflow and measuring the gaps between the two plots. A factor of safety may be applied if desired.

Generally, **detention time** vary from 2 to 8 hours but may be even 12 hours or more in some cases. When larger detention times are required, the equalization unit is sometimes provided in the form of facultative aerated lagoon.

## LECTURE-17

### Grit Chambers

Grit chambers are basin to remove the inorganic particles to prevent damage to the pumps, and to prevent their accumulation in sludge digestors.

### Types of Grit Chambers

Grit chambers are of two types: mechanically cleaned and manually cleaned. In **mechanically cleaned** grit chamber, scraper blades collect the grit settled on the floor of the grit chamber. The grit so collected is elevated to the ground level by several mechanisms such as bucket elevators, jet pump and air lift. The grit washing mechanisms are also of several designs most of which are agitation devices using either water or air to produce washing action. **Manually cleaned** grit chambers should be cleaned atleast once a week. The simplest method of cleaning is by means of shovel.

### Aerated Grit Chamber

An aerated grit chamber consists of a standard spiral flow aeration tank provided with air diffusion tubes placed on one side of the tank. The grit particles tend to settle down to the bottom of the tank at rates dependant upon the particle size and the bottom velocity of roll of the spiral flow, which in turn depends on the rate of air diffusion through diffuser tubes and shape of aeration tank. The heavier particles settle down whereas the lighter organic particles are carried with roll of the spiral motion.

### Principle of Working of Grit Chamber

Grit chambers are nothing but like sedimentation tanks, designed to separate the intended heavier inorganic materials (specific gravity about 2.65) and to pass forward the lighter organic materials. Hence, the flow velocity should neither be too low as to cause the settling of lighter organic matter, nor should it be too high as not to cause the settlement of the silt and grit present in the sewage. This velocity is called "differential sedimentation and differential scouring velocity". The scouring velocity determines the optimum **flow through velocity**. This may be explained by the fact that the critical velocity of flow ' $v_c$ ' beyond which particles of a certain size and density once settled, may be again introduced into the stream of flow. It should always be less than the scouring velocity of grit particles. The critical velocity of scour is given by Schield's formula:

$$V = 3 \text{ to } 4.5 (g(S_s - 1)d)^{1/2}$$

A horizontal velocity of flow of 15 to 30 cm/sec is used at peak flows. This same velocity is to be maintained at all fluctuation of flow to ensure that only organic solids and not the grit is scoured from the bottom.

### Types of Velocity Control Devices

1. A suture weir in a channel of rectangular cross section, with free fall downstream of the channel.
2. A parabolic shaped channel with a rectangular weir.
3. A rectangular shaped channel with a parshall flume at the end which would also help easy flow measurement.

### Design of Grit Chambers

#### **Settling Velocity**

The settling velocity of discrete particles can be determined using appropriate equation depending upon Reynolds number.

- Stoke's law:  $v = \frac{g(S_s - 1)d^2}{18\mu}$
- 

Stoke's law holds good for Reynolds number,  $R_e$  below 1.

$$R_e = \frac{\rho v d}{\mu}$$

For grit particles of specific gravity 2.65 and liquid temperature at 10°C,  $\mu = 1.01 \times 10^{-6} \text{ m}^2/\text{s}$ . This corresponds to particles of size less than 0.1 mm.

- Transition law: The design of grit chamber is based on removal of grit particles with minimum size of 0.15 mm and therefore Stoke's law is not applicable to determine the settling velocity of grit particles for design purposes.

$$v^2 = \frac{4g(\rho_p - \rho)d}{3C_D\rho}$$

where,  $C_D$  = drag coefficient Transition flow conditions hold good for Reynolds number,  $R_e$  between 1 and 1000. In this range  $C_D$  can be approximated by

$$C_D = \frac{18.5}{R_e^{0.6}} = \frac{18.5}{(\rho v d / \mu)^{0.6}}$$

### Primary Sedimentation

Primary sedimentation in a municipal wastewater treatment plant is generally plain sedimentation without the use of chemicals. In treating certain industrial wastes chemically aided sedimentation may be involved. In either case, it constitutes **flocculent settling**, and the particles do not remain discrete as in the case of grit, but tend to agglomerate or coagulate during settling. Thus, their diameter keeps increasing and settlement proceeds at an over increasing velocity. Consequently, they trace a curved profile.

The settling tank design in such cases depends on both **surface loading** and **detention time**.

Long tube settling tests can be performed in order to estimate specific value of surface loading and detention time for desired efficiency of clarification for a given industrial wastewater using recommended methods of testing. Scale-up factors used in this case range from 1.25 to 1.75 for the overflow rate, and from 1.5 to 2.0 for detention time when converting laboratory results to the prototype design.

For primary settling tanks treating municipal or domestic sewage, laboratory tests are generally not necessary, and recommended design values given in table may be used. Using an appropriate value of surface loading from table, the required tank area is computed. Knowing the average depth, the detention time is then computed. Excessively high detention time (longer than 2.5 h) must be avoided especially in warm climates where anaerobicity can be quickly induced.

#### Design parameters for settling tank

Types of settling	Overflow rate m <sup>3</sup> /m <sup>2</sup> /day		Solids loading kg/m <sup>2</sup> /day		Depth	Detention time
	Average	Peak	Average	Peak		
Primary settling only	25-30	50-60	-	-	2.5- 3.5	2.0-2.5
Primary settling followed by secondary treatment	35-50	60-120	-	-	2.5- 3.5	
Primary settling with activated sludge return	25-35	50-60	-	-	3.5- 4.5	-
Secondary settling for trickling filters	15-25	40-50	70-120	190	2.5- 3.5	1.5-2.0
Secondary settling for activated sludge (excluding extended aeration)	15-35	40-50	70-140	210	3.5- 4.5	-
Secondary settling for extended aeration	8-15	25-35	25-120	170	3.5- 4.5	-



## LECTURE-18

### Classification of Micro organisms

1. **Nutritional Requirements:** On the basis of chemical form of carbon required, microorganisms are classified as
  - a. Autotrophic: organisms that use  $\text{CO}_2$  or  $\text{HCO}_3^-$  as their sole source of carbon.
  - b. Heterotrophic: organisms that use carbon from organic compounds.

**Energy Requirements:** On the basis of energy source required, microorganisms are classified as

- . Phototrophs: organisms that use light as their energy source.
  - a. Chemotrophs: organisms that employ oxidation-reduction reactions to provide energy. They are further classified on the basis of chemical compounds oxidized (i.e., electron donor)
    - i. Chemoorganotrophs: Organisms that use complex organic molecules as their electron donor.
    - ii. Chemoautotrophs: Organisms that use simple inorganic molecules such as hydrogen sulfide or ammonia as their electron donor.

**Temperature Range:** On the basis of temperature range within which they can proliferate, microorganisms are classified as

- . Psychrophilic: organisms whose growth is optimum within 15 to 30°C.
  - a. Mesophilic: organisms whose growth is optimum within 30 to 45°C.
  - b. Thermophilic: organisms whose growth is optimum within 45 to 70°C.

**Oxygen Requirements:** On the basis of oxygen requirement microorganisms are classified as

- . Aerobes: organisms that use molecular oxygen as electron acceptor.
  - a. Anaerobes: organisms that use some molecule other than molecular oxygen as electron acceptor.
  - b. Facultative organisms : organisms that can use either molecular oxygen or some other chemical compound as electron acceptor.

### Growth Pattern of Micro organisms

When a small number of viable bacterial cells are placed in a close vessel containing excessive food supply in a suitable environment, conditions are established in which unrestricted growth takes place. However, growth of an organism do not go on indefinitely, and after a characteristic size is reached, the cell divides due to hereditary and internal limitations. The growth rate may follow a pattern similar to as shown in figure

## Characteristic Growth Curves of Cultures of Microorganisms

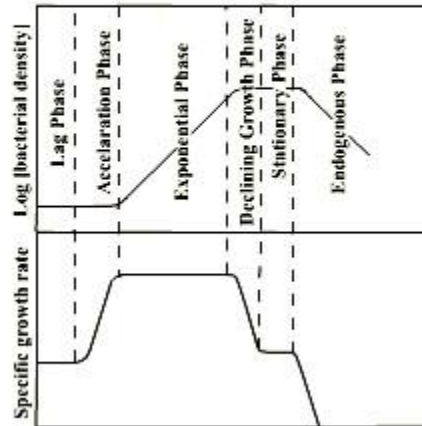

The curve shown may be divided into six well defined phases:

1. *Lag Phase*: adaptation to new environment, long generation time and null growth rate.
2. *Acceleration phase*: decreasing generation time and increasing growth rate.
3. *Exponential phase*: minimal and constant generation time, maximal and constant specific growth rate and maximum rate of substrate conversion.
4. *Declining growth phase*: increasing generation time and decreasing specific growth rate due to gradual decrease in substrate concentration and increased accumulation of toxic metabolites.
5. *Stationary phase*: exhaustion of nutrients, high concentration of toxic metabolites, and cells in a state of suspended animation.
6. *Endogenous phase*: endogenous metabolism, high death rate and cell lysis.

### Biomass Growth Rate

The most widely used expression for the growth rate of micro organisms is given by Monod:

$$\text{Total rate of microbial growth, } \frac{dX}{dt} = \mu_m \frac{X S}{K_s + S}$$

where,

$\mu_m$  = maximum specific growth rate

X = micro organism concentration

S = substrate concentration

$K_s$  = substrate concentration at one half the maximum growth rate

Similarly, rate of substrate utilization,

$$\frac{dS}{dt} = \frac{k X S}{K_s + S}$$

where,

k = maximum specific substrate utilization rate

### **Maintenance as Endogenous Respiration**

Net growth rate of micro organisms is computed by subtracting from the total growth rate, the rate of micro organisms endogenously decayed to satisfy maintenance energy requirement. Therefore,

$$\text{Net rate of microbial growth} = \mu_m \frac{X S}{K_s + S} - k_d X$$

where,  $k_d$  = endogenous decay coefficient

### **Growth Yield**

Growth yield is defined as the incremental increase in biomass which results from the utilization of the incremental amount of substrate. The maximum specific growth rate is given by:  $\mu_m = Y \cdot k$

where,  $Y$  is the maximum yield coefficient and is defined as the ratio of maximum mass of cells formed to the mass of substrate utilized. The coefficients  $Y$ ,  $k_d$ ,  $k$  and  $K_s$  are designated as kinetic coefficients. The values of kinetic coefficients depend upon the nature of wastewater and operational and environmental conditions in biological reactor. The biological reactors can be completely mixed flow or plug flow reactor with or without recycle.

### **Activated Sludge Process**

The most common suspended growth process used for municipal wastewater treatment is the activated sludge process as shown in figure:

## LECTURE-19

### **Flow sheet of an activated sludge system**

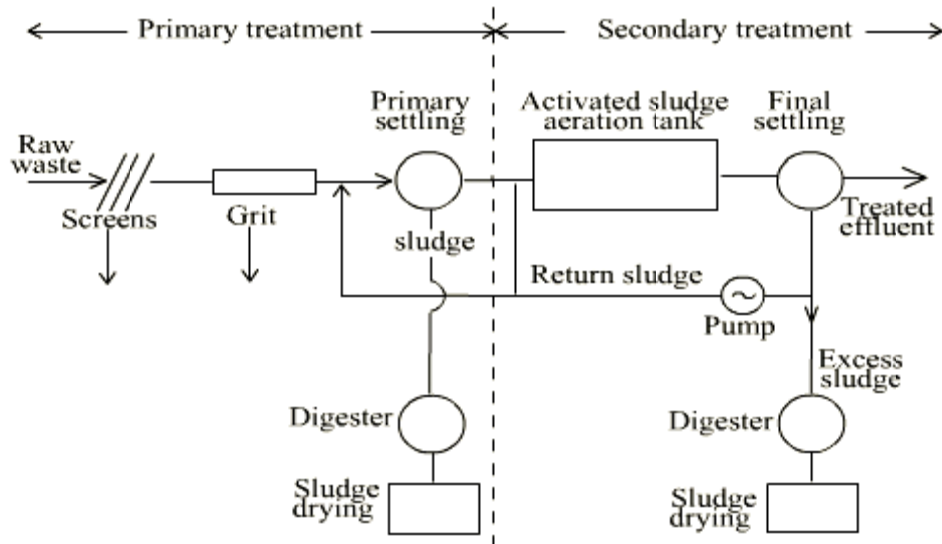

Activated sludge plant involves:

1. wastewater aeration in the presence of a microbial suspension,
2. solid-liquid separation following aeration,
3. discharge of clarified effluent,
4. wasting of excess biomass, and
5. return of remaining biomass to the aeration tank.

In activated sludge process wastewater containing organic matter is aerated in an aeration basin in which micro-organisms metabolize the suspended and soluble organic matter. Part of organic matter is synthesized into new cells and part is oxidized to  $\text{CO}_2$  and water to derive energy. In activated sludge systems the new cells formed in the reaction are removed from the liquid stream in the form of a flocculent sludge in settling tanks. A part of this settled biomass, described as activated sludge is returned to the aeration tank and the remaining forms waste or excess sludge.

### **Activated Sludge Process Variables**

The main variables of activated sludge process are the mixing regime, loading rate, and the flow scheme.

## Mixing Regime

Generally two types of mixing regimes are of major interest in activated sludge process: **plug flow** and **complete mixing**. In the first one, the regime is characterized by orderly flow of mixed liquor through the aeration tank with no element of mixed liquor overtaking or mixing with any other element. There may be lateral mixing of mixed liquor but there must be no mixing along the path of flow.

In complete mixing, the contents of aeration tank are well stirred and uniform throughout. Thus, at steady state, the effluent from the aeration tank has the same composition as the aeration tank contents.

The type of mixing regime is very important as it affects (1) oxygen transfer requirements in the aeration tank, (2) susceptibility of biomass to shock loads, (3) local environmental conditions in the aeration tank, and (4) the kinetics governing the treatment process.

## Loading Rate

A loading parameter that has been developed over the years is the **hydraulic retention time** (HRT),  $\theta$ , d

$$\theta = \frac{V}{Q}$$

$V$  = volume of aeration tank,  $m^3$ , and  $Q$  = sewage inflow,  $m^3/d$

Another empirical loading parameter is **volumetric organic loading** which is defined as the BOD applied per unit volume of aeration tank, per day.

A rational loading parameter which has found wider acceptance and is preferred is **specific substrate utilization rate**,  $q$ , per day.

$$q = \frac{Q(S_0 - S_e)}{V X}$$

A similar loading parameter is **mean cell residence time** or **sludge retention time** (SRT),  $\theta_c$ , d

$$\theta_c = \frac{V X}{Q_w X_r + (Q - Q_w) X_e}$$

where  $S_0$  and  $S_e$  are influent and effluent organic matter concentration respectively, measured as  $BOD_5$  ( $g/m^3$ ),  $X$ ,  $X_e$  and  $X_r$  are MLSS concentration in aeration tank, effluent and return sludge respectively, and  $Q_w$  = waste activated sludge rate.

Under steady state operation the mass of waste activated sludge is given by

$$Q_w X_r = YQ(S_0 - S_e) - k_d XV$$

where  $Y$  = maximum yield coefficient (microbial mass synthesized / mass of substrate utilized) and  $k_d$  = endogenous decay rate ( $d^{-1}$ ).

From the above equation it is seen that  $1/\theta_c = Yq - k_d$

If the value of  $S_e$  is small as compared  $S_o$ ,  $q$  may also be expressed as **Food to Microorganism ratio**, F/M

$$F/M = Q(S_o - S_e) / XV = QS_o / XV$$

The  $\theta_c$  value adopted for design controls the effluent quality, and settleability and drainability of biomass, oxygen requirement and quantity of waste activated sludge.

### Flow Scheme

The flow scheme involves:

- the pattern of sewage addition
- the pattern of sludge return to the aeration tank and
- the pattern of aeration.

Sewage addition may be at a single point at the inlet end or it may be at several points along the aeration tank. The sludge return may be directly from the settling tank to the aeration tank or through a sludge reaeration tank. Aeration may be at a uniform rate or it may be varied from the head of the aeration tank to its end.

### Conventional System and its Modifications

The conventional system maintains a plug flow hydraulic regime. Over the years, several modifications to the conventional system have been developed to meet specific treatment objectives. In **step aeration** settled sewage is introduced at several points along the tank length which produces more uniform oxygen demand throughout. **Tapered aeration** attempts to supply air to match oxygen demand along the length of the tank. **Contact stabilization** provides for reaeration of return activated sludge from from the final clarifier, which allows a smaller aeration or contact tank. **Completely mixed** process aims at instantaneous mixing of the influent waste and return sludge with the entire contents of the aeration tank. Extended aeration process operates at a low organic load producing lesser quantity of well stabilized sludge.

### Design Consideration

The items for consideration in the design of activated sludge plant are aeration tank capacity and dimensions, aeration facilities, secondary sludge settling and recycle and excess sludge wasting.

### Aeration Tank

The **volume of aeration tank** is calculated for the selected value of  $\theta_c$  by assuming a suitable value of MLSS concentration,  $X$ .

$$VX = \frac{YQ\theta_c(S_0 - S)}{1 + k_d\theta_c}$$

Alternately, the tank capacity may be designed from

$$F/M = QS_0 / XV$$

Hence, the **first step** in designing is to choose a suitable value of  $\theta_c$  (**or F/M**) which depends on the expected winter temperature of mixed liquor, the type of reactor, expected settling characteristics of the sludge and the nitrification required. The choice generally lies between 5 days in warmer climates to 10 days in temperate ones where nitrification is desired along with good BOD removal, and complete mixing systems are employed.

The **second step** is to select two interrelated parameters **HRT, t and MLSS concentration**. It is seen that economy in reactor volume can be achieved by assuming a large value of X. However, it is seldom taken to be more than 5000 g/m<sup>3</sup>. For typical domestic sewage, the MLSS value of 2000-3000 mg/l if conventional plug flow type aeration system is provided, or 3000-5000 mg/l for completely mixed types. Considerations which govern the upper limit are: initial and running cost of sludge recirculation system to maintain a high value of MLSS, limitations of oxygen transfer equipment to supply oxygen at required rate in small reactor volume, increased solids loading on secondary clarifier which may necessitate a larger surface area, design criteria for the tank and minimum HRT for the aeration tank.

The **length** of the tank depends upon the type of activated sludge plant. Except in the case of extended aeration plants and completely mixed plants, the aeration tanks are designed as long narrow channels. The **width** and **depth** of the aeration tank depends on the type of aeration equipment employed. The depth controls the aeration efficiency and usually ranges from 3 to 4.5 m. The width controls the mixing and is usually kept between 5 to 10 m. **Width-depth ratio** should be adjusted to be between 1.2 to 2.2. The length should not be less than 30 or not ordinarily longer than 100 m.

### Oxygen Requirements

Oxygen is required in the activated sludge process for the oxidation of a part of the influent organic matter and also for the endogenous respiration of the micro-organisms in the system. The total oxygen requirement of the process may be formulated as follows:

$$O_2 \text{ required (g/d)} = \frac{Q(S_0 - S)}{f} - 1.42 Q_w X_r$$

where,  $f$  = ratio of  $BOD_5$  to ultimate BOD and  $1.42$  = oxygen demand of biomass (g/g)

The formula does not allow for nitrification but allows only for carbonaceous BOD removal.

## LECTURE-20

### Aeration Facilities

The aeration facilities of the activated sludge plant are designed to provide the calculated oxygen demand of the wastewater against a specific level of dissolved oxygen in the wastewater.

### Secondary Settling

Secondary settling tanks, which receive the biologically treated flow undergo zone or compression settling. **Zone settling** occurs beyond a certain concentration when the particles are close enough together that interparticulate forces may hold the particles fixed relative to one another so that the whole mass tends to settle as a single layer or "blanket" of sludge. The rate at which a sludge blanket settles can be determined by timing its position in a settling column test whose results can be plotted as shown in figure.

**Compression settling** may occur at the bottom of a tank if particles are in such a concentration as to be in physical contact with one another. The weight of particles is partly supported by the lower layers of particles, leading to progressively greater compression with depth and thickening of sludge. From the settling column test, the limiting solids flux required to reach any desired underflow concentration can be estimated, from which the required tank area can be computed.

The solids load on the clarifier is estimated in terms of  $(Q+R)X$ , while the overflow rate or surface loading is estimated in terms of flow  $Q$  only (not  $Q+R$ ) since the quantity  $R$  is withdrawn from the bottom and does not contribute to the overflow from the tank. The secondary settling tank is particularly sensitive to fluctuations in flow rate and on this account it is recommended that the units be designed not only for average overflow rate but also for peak overflow rates. Beyond an MLSS concentration of  $2000$  mg/l the clarifier design is often controlled by the solids loading rate rather than the overflow rate. Recommended design values for treating domestic sewage in final clarifiers and mechanical thickeners (which also fall in this category of compression settling) are given in lecture 22.

### Sludge Recycle

The MLSS concentration in the aeration tank is controlled by the sludge recirculation rate and the sludge settleability and thickening in the secondary sedimentation tank.

$$\frac{Q_r}{Q} = \frac{X}{X_r - X}$$



where  $Q_r$  = Sludge recirculation rate,  $m^3/d$

The sludge settleability is determined by sludge volume index (SVI) defined as volume occupied in mL by one gram of solids in the mixed liquor after settling for 30 min. If it is assumed that sedimentation of suspended solids in the laboratory is similar to that in sedimentation tank, then  $X_r = 10^6/SVI$ . Values of SVI between 100 and 150 ml/g indicate good settling of suspended solids. The  $X_r$  value may not be taken more than  $10,000 \text{ g/m}^3$  unless separate thickeners are provided to concentrate the settled solids or secondary sedimentation tank is designed to yield a higher value.

### **Excess Sludge Wasting**

The sludge in the aeration tank has to be wasted to maintain a steady level of MLSS in the system. The excess sludge quantity will increase with increasing F/M and decrease with increasing temperature. Excess sludge may be wasted either from the sludge return line or directly from the aeration tank as mixed liquor. The latter is preferred as the sludge concentration is fairly steady in that case. The excess sludge generated under steady state operation may be estimated by

$$\theta_c = \frac{VX}{Q_w X_r}$$

$$\text{or } Q_w X_r = YQ(S_0 - S) - k_d XV$$

### **Design of Completely Mixed Activated Sludge System**

Design a completely mixed activated sludge system to serve 60000 people that will give a final effluent that is nitrified and has 5-day BOD not exceeding 25 mg/l. The following design data is available.

Sewage flow = 150 l/person-day = 9000  $m^3$ /day  $BOD_5 = 54 \text{ g/person-day} = 360 \text{ mg/l}$ ;  $BOD_u = 1.47 \text{ } BOD_5$  Total kjeldahl nitrogen (TKN) = 8 g/person-day = 53 mg/l Phosphorus = 2 g/person-day = 13.3 mg/l Winter temperature in aeration tank = 18°C Yield coefficient  $Y = 0.6$ ; Decay constant  $K_d = 0.07$  per day; Specific substrate utilization rate =  $0.038 \text{ mg/l}^{-1} \text{ (h)}^{-1}$  at 18°C Assume 30% raw  $BOD_5$  is removed in primary sedimentation, and  $BOD_5$  going to aeration is, therefore, 252 mg/l ( $0.7 \times 360 \text{ mg/l}$ ).

Design:

**(a) Selection of  $\theta_c$ ,  $t$  and MLSS concentration:**

Considering the operating temperature and the desire to have nitrification and good sludge settling characteristics, adopt  $\theta_c = 5d$ . As there is no special fear of toxic inflows, the HRT,  $t$  may be kept between 3-4 h, and MLSS = 4000 mg/l.

**(b) Effluent BOD<sub>5</sub>:**

$$\text{Substrate concentration, } S = \frac{1}{qY} (1/\theta_c + k_d) = \frac{1}{(0.038)(0.6)} (1/5 + 0.07)$$

$$S = 12 \text{ mg/l.}$$

Assume suspended solids (SS) in effluent = 20 mg/l and VSS/SS = 0.8.

If degradable fraction of volatile suspended solids (VSS) = 0.7 (check later), BOD<sub>5</sub> of VSS in effluent = 0.7(0.8x20) = 11mg/l.

Thus, total effluent BOD<sub>5</sub> = 12 + 11 = 23 mg/l (acceptable).

**(c) Aeration Tank:**

$$VX = \frac{YQ\theta_c(S_0 - S)}{1 + k_d\theta_c} \text{ where } X = 0.8(4000) = 3200 \text{ mg/l}$$

$$\text{or } 3200 V = \frac{(0.6)(5)(9000)(252-12)}{[1 + (0.07)(5)]}$$

$$[1 + (0.07)(5)]$$

$$V = 1500 \text{ m}^3$$

$$\text{Detention time, } t = \frac{1500 \times 24}{9000} = 4\text{h}$$

$$F/M = \frac{(252-12)(9000)}{(3200)(1500)} = 0.45 \text{ kg BOD}_5 \text{ per kg MLSS per day}$$

Let the aeration tank be in the form of four square shaped compartments operated in two parallel rows, each with two cells measuring 11m x 11m x 3.1m

**(d) Return Sludge Pumping:**

If suspended solids concentration of return flow is 1% = 10,000 mg/l

$$R = \frac{\text{MLSS}}{(10000) - \text{MLSS}} = 0.67$$

$$Q_r = 0.67 \times 9000 = 6000 \text{ m}^3/\text{d}$$

**(e) Surplus Sludge Production:**

$$\text{Net VSS produced } Q_w X_r = \frac{VX}{\theta_c} = \frac{(3200)(1500)}{(5)} (10^3/10^6) = 960 \text{ kg/d}$$

$$\text{or SS produced} = 960/0.8 = 1200 \text{ kg/d}$$

If SS are removed as underflow with solids concentration 1% and assuming specific gravity of sludge as 1.0,

$$\text{Liquid sludge to be removed} = 1200 \times 100/1 = 120,000 \text{ kg/d} = 120 \text{ m}^3/\text{d}$$

**(f) Oxygen Requirement:**

For carbonaceous demand,

$$\begin{aligned}\text{oxygen required} &= (\text{BOD}_u \text{ removed}) - (\text{BOD}_u \text{ of solids leaving}) \\ &= 1.47 (2160 \text{ kg/d}) - 1.42 (960 \text{ kg/d}) \\ &= 72.5 \text{ kg/h}\end{aligned}$$

For nitrification, oxygen required = 4.33 (TKN oxidized, kg/d)

Incoming TKN at 8.0 g/ person-day = 480 kg/day. Assume 30% is removed in primary sedimentation and the balance 336 kg/day is oxidized to nitrates. Thus, oxygen required = 4.33 x 336 = 1455 kg/day = 60.6 kg/h

Total oxygen required = 72.5 + 60.6 = 133 kg/h = 1.0 kg/kg of BOD<sub>u</sub> removed.

Oxygen uptake rate per unit tank volume = 133/1500 = 90.6 mg/h/l tank volume

**(g) Power Requirement:**

Assume oxygenation capacity of aerators at field conditions is only 70% of the capacity at standard conditions and mechanical aerators are capable of giving 2 kg oxygen per kWh at standard conditions.

$$\begin{aligned}\text{Power required} &= \frac{136}{0.7 \times 2} = 97 \text{ kW (130 hp)} \\ &= (97 \times 24 \times 365) / 60,000 = 14.2 \text{ kWh/year/person}\end{aligned}$$

**Theory of Aeration**

Aeration is a gas-liquid mass transfer process in which the driving force in the liquid phase is the concentration gradient ( $C_s - C$ ) for slightly soluble gases.

$$\text{Mass transfer per unit time} = K_L \cdot a (C_s - C)$$

where,  $K_L$  = Liquid film coefficient

$$= \frac{\text{Diffusion coefficient of liquid (D)}}{\text{Thickness of film (Y)}}$$

$a$  = Interfacial area per unit volume

$C_s$  = saturation concentration at the gas-liquid interface and  $C$  = some lower value in the body of the liquid.

The value of  $a$  increases as finer and finer droplets are formed, thus increasing the gas transfer. However, in practice, it is not possible to measure this area and hence the overall coefficient ( $K_L \cdot a$ ) per unit time, is determined by experimentation.

**Adjustment for Field Conditions**

The oxygen transfer capacity under field conditions can be calculated from the standard oxygen transfer capacity by the formula:

$$N = [N_s(C_s - C_L) \times 1.024^{T-20} \alpha \theta] / 9.2$$

where,

$N$  = oxygen transferred under field conditions, kg  $O_2$ /h.

$N_s$  = oxygen transfer capacity under standard conditions, kg  $O_2$ /h.

$C_s$  = DO saturation value for sewage at operating temperature.

$C_L$  = operating DO level in aeration tank usually 1 to 2 mg/L.

$T$  = Temperature, degree C.

$\alpha$  = Correction factor for oxygen transfer for sewage, usually 0.8 to 0.85.

### Aeration Facilities

- Oxygen may be supplied either by surface aerators or diffused aerators employing fine or coarse diffusers.
- The aeration devices apart from supplying the required oxygen shall also provide adequate mixing in order that the entire MLSS present in the aeration tank will be available for biological activity.
- Aerators are rated based on the amount of oxygen they can transfer to tap water under standard conditions of 20°C, 760 mm Hg barometric pressure and zero DO.

## LECTURE-21

### Trickling Filters

- Trickling filter is an **attached growth process** i.e. process in which microorganisms responsible for treatment are attached to an inert packing material. Packing material used in attached growth processes include rock, gravel, slag, sand, redwood, and a wide range of plastic and other synthetic materials.

### Process Description

- The wastewater in trickling filter is distributed over the top area of a vessel containing non-submerged packing material.
- Air circulation in the void space, by either natural draft or blowers, provides oxygen for the microorganisms growing as an attached biofilm.
- During operation, the organic material present in the wastewater is metabolised by the biomass attached to the medium. The biological slime grows in thickness as the organic matter abstracted from the flowing wastewater is synthesized into new cellular material.
- The thickness of the aerobic layer is limited by the depth of penetration of oxygen into the microbial layer.
- The micro-organisms near the medium face enter the endogenous phase as the substrate is metabolised before it can reach the micro-organisms near the medium face as a result of increased thickness of the slime layer and lose their ability to cling to the media surface. The liquid then washes the slime off the medium and a new slime layer starts to grow. This phenomenon of losing the slime layer is called **sloughing**.

- The sloughed off film and treated wastewater are collected by an underdrainage which also allows circulation of air through filter. The collected liquid is passed to a settling tank used for solid- liquid separation.

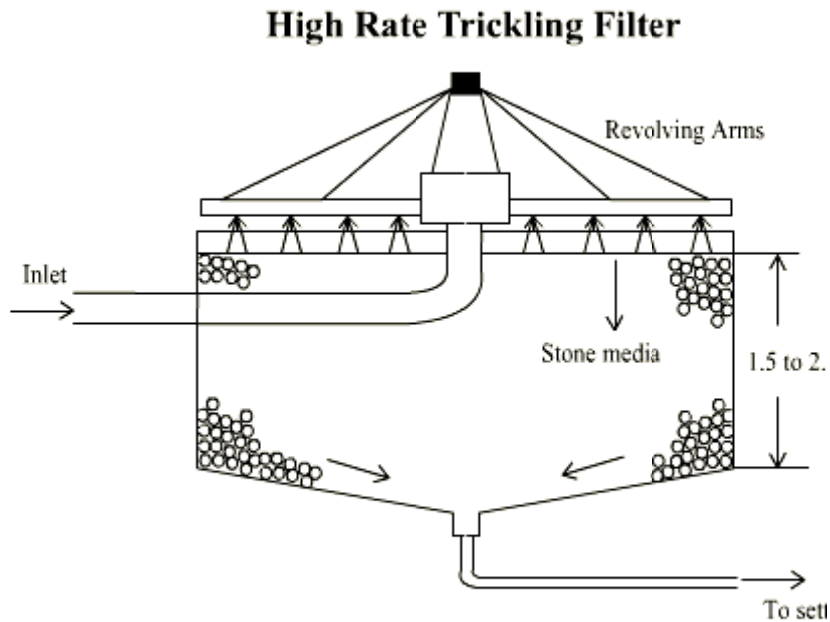

### Types of Filters

Trickling filters are classified as high rate or low rate, based on the organic and hydraulic loading applied to the unit.

S.No.	Design Feature	Low Rate Filter	High Rate Filter
1.	Hydraulic loading, $m^3/m^2.d$	1 - 4	10 - 40
2.	Organic loading, kg BOD / $m^3.d$	0.08 - 0.32	0.32 - 1.0
3.	Depth, m.	1.8 - 3.0	0.9 - 2.5
4.	Recirculation ratio	0	0.5 - 3.0 (domestic wastewater) upto 8 for strong industrial wastewater.

- The hydraulic loading rate is the total flow including recirculation applied on unit area of the filter in a day, while the organic loading rate is the 5 day 20°C BOD, excluding the BOD of the recirculant, applied per unit volume in a day.
- Recirculation is generally not adopted in low rate filters.
- A well operated low rate trickling filter in combination with secondary settling tank may remove 75 to 90% BOD and produce highly nitrified effluent. It is suitable for treatment of low to medium strength domestic wastewaters.
- The high rate trickling filter, single stage or two stage are recommended for medium to relatively high strength domestic and industrial wastewater. The BOD removal efficiency is around 75 to 90% but the effluent is only partially nitrified.
- Single stage unit consists of a primary settling tank, filter, secondary settling tank and facilities for recirculation of the effluent. Two stage filters consist of two filters in series with a primary settling tank, an intermediate settling tank which may be omitted in certain cases and a final settling tank.

### Process Design

#### **Flow sheet of a trickling filter system**

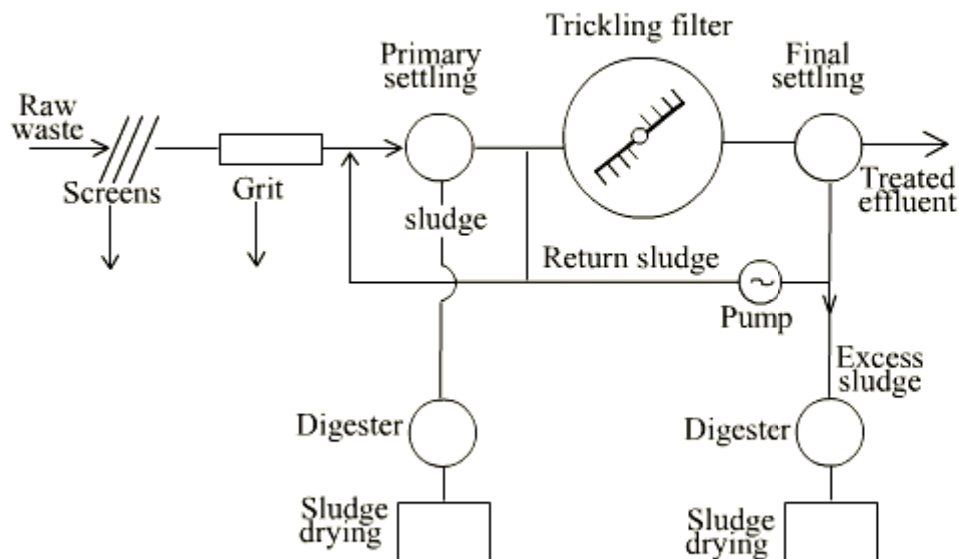

Generally trickling filter design is based on empirical relationships to find the required filter volume for a designed degree of wastewater treatment. Types of equations:

1. NRC equations (National Research Council of USA)
2. Rankins equation
3. Eckenfelder equation

#### 4. Galler and Gotaas equation

NRC and Rankin's equations are commonly used. NRC equations give satisfactory values when there is no re-circulation, the seasonal variations in temperature are not large and fluctuations with high organic loading. Rankin's equation is used for high rate filters.

**NRC equations:** These equations are applicable to both low rate and high rate filters. The efficiency of single stage or first stage of two stage filters,  $E_2$  is given by

$$E_2 = \frac{100}{1 + 0.44(F_{1,BOD}/V_1 \cdot Rf_1)^{1/2}}$$

For the second stage filter, the efficiency  $E_3$  is given by

$$E_3 = \frac{100}{[(1 + 0.44)/(1 - E_2)](F_{2,BOD}/V_2 \cdot Rf_2)^{1/2}}$$

where  $E_2$  = % efficiency in BOD removal of single stage or first stage of two-stage filter,  $E_3$  = % efficiency of second stage filter,  $F_{1,BOD}$  = BOD loading of settled raw sewage in single stage of the two-stage filter in kg/d,  $F_{2,BOD} = F_{1,BOD}(1 - E_2)$  = BOD loading on second-stage filter in kg/d,  $V_1$  = volume of first stage filter,  $m^3$ ;  $V_2$  = volume of second stage filter,  $m^3$ ;  $Rf_1$  = Recirculation factor for first stage,  $R_1$  = Recirculation ratio for first stage filter,  $Rf_2$  = Recirculation factor for second stage,  $R_2$  = Recirculation ratio for second stage filter.

**Rankins equation:** This equation also known as Tentative Method of Ten States USA has been successfully used over wide range of temperature. It requires following conditions to be observed for single stage filters:

1. Raw settled domestic sewage BOD applied to filters should not exceed 1.2 kg BOD<sub>5</sub>/day/  $m^3$  filter volume.
2. Hydraulic load (including recirculation) should not exceed 30  $m^3/m^2$  filter surface-day.

Recirculation ratio (R/Q) should be such that BOD entering filter (including recirculation) is not more than three times the BOD expected in effluent. This implies that as long as the above conditions are satisfied efficiency is only a function of recirculation and is given by:

$$E = \frac{(R/Q) + 1}{(R/Q) + 1.5}$$

## LECTURE-22

### Other Aerobic Treatment Units

1. **Stabilization ponds:** The stabilization ponds are open flow through basins specifically designed and constructed to treat sewage and biodegradable industrial wastes. They provide long detention periods extending from a few to several days.
2. **Aerated lagoons:** Pond systems, in which oxygen is provided through mechanical aeration rather than algal photosynthesis are called aerated lagoons.
3. **Oxidation ditch:** The oxidation ditch is a modified form of "extended aeration" of activated sludge process. The ditch consists of a long continuous channel oval in shape with two surface rotors placed across the channel.

### **Anaerobic Treatment**

The anaerobic waste treatment process is an effective method for the treatment of many organic wastes. The treatment has a number of advantages over aerobic treatment process, namely,

- the energy input of the system is low as no energy is required for oxygenation,
- lower production of excess sludge( biological synthesis) per unit mass of substrate utilized,
- lower nutrient requirement due to lower biological synthesis, and
- degradation leads to production of biogas which is a valuable source of energy.

### **Fundamental Microbiology**

The anaerobic treatment of organic wastes resulting in the production of carbon dioxide and methane, involves two distinct stages. In the first stage, complex waste components, including fats, proteins, and polysaccharides are first hydrolyzed by a heterogeneous group of facultative and anaerobic bacteria. These bacteria then subject the products of hydrolysis to fermentations,  $\square$ -oxidations, and other metabolic processes leading to the formation of simple organic compounds, mainly short-chain (volatile) acids and alcohols. The first stage is commonly referred to as "**acid fermentation**". However in the second stage the end products of the first stage are converted to gases (mainly methane and carbon dioxide) by several different species of strictly anaerobic bacteria. This stage is generally referred to as "**methane fermentation**".



### Sequential Mechanism of Anaerobic Waste Treatment

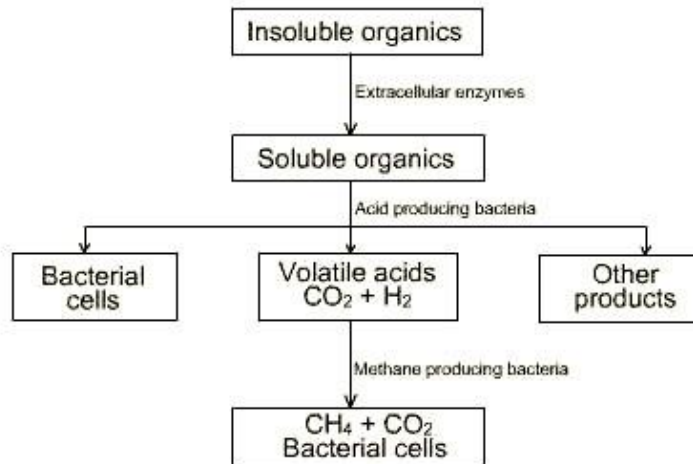

The primary acids produced during acid fermentation are propionic and acetic acid. It is reported that only one group of methane bacteria is necessary for methane fermentation of acetic acid, whereas propionic acid, which is fermented through acetic acid requires two different groups of methane bacteria. The methane fermentation reactions for these two acids are:

Acetic acid:



Propionic acid:

I<sup>st</sup> Step:



II<sup>nd</sup> Step:

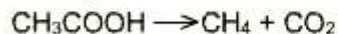

Overall:



The bacteria responsible for acid fermentation are relatively tolerant to changes in pH and temperature and have a much higher rate of growth than the bacteria responsible for methane fermentation. As a result, methane fermentation is generally assumed to be the rate limiting step in anaerobic wastewater treatment.

### . Anaerobic Reactor

Various types of anaerobic units that have been developed are as follows:

- **Upflow anaerobic filters** packed with either pebbles, stones, PVC sheets, etc. as media to support submerged biological growths (fixed film). The units are reported to work well but a likely problem is accumulation of solids in the interstices.

- **Downflow anaerobic filters** packed with similar media as above but not to be confused with usual trickling filters which are aerobic. In the anaerobic units, the inlet and outlet are so placed that the media and fixed film stay submerged.
- **UASB type units** in which no special media have to be used since the sludge granules themselves act as the 'media' and stay in suspension. These are commonly preferred.
- **Fluidized bed units** filled with sand or plastic granules are used with recirculation under required pressure to keep the entire mass fluidized and the sludge distributed over the entire reactor volume. Their power consumption is higher.

## LECTURE-23

### UASB Units

**UASB type units** are one in which no special media have to be used since the sludge granules themselves act as the 'media' and stay in suspension. UASB system is not patented. A typical arrangement of a UASB type treatment plant for municipal sewage would be as follows:

1. Initial pumping
2. Screening and degritting
3. Main UASB reactor
4. Gas collection and conversion or conveyance
5. Sludge drying bed
6. Post treatment facility

In the UASB process, the whole waste is passed through the anaerobic reactor in an upflow mode, with a hydraulic retention time (HRT) of only about 8-10 hours at average flow. No prior sedimentation is required. The anaerobic unit does not need to be filled with stones or any other media; the upflowing sewage itself forms millions of small "granules" or particles of sludge which are held in suspension and provide a large surface area on which organic matter can attach and undergo biodegradation. A high solid retention time (SRT) of 30-50 or more days occurs within the unit. No mixers or aerators are required. The gas produced can be collected and used if desired. Anaerobic systems function satisfactorily when temperatures inside the reactor are above 18-20°C. Excess sludge is removed from time to time through a separate pipe and sent to a simple sand bed for drying.

### Design Approach

**Size of Reactor:** Generally, UASBs are considered where temperature in the reactors will be above 20°C. At equilibrium condition, sludge withdrawn has to be equal to sludge produced daily. The sludge produced daily depends on the characteristics of the raw wastewater since it is the sum total of (i) the new VSS produced as a result of BOD removal, the yield coefficient being assumed as 0.1 g VSS/ g BOD removed, (ii) the non-degradable residue of the VSS coming in the inflow assuming 40% of the VSS are degraded and residue is 60%, and (iii) Ash received in the inflow, namely TSS-VSS mg/l. Thus, at steady state conditions,

$$\text{SRT} = \frac{\text{Total sludge present in reactor, kg}}{\text{Sludge withdrawn per day, kg/d}}$$

= 30 to 50 days.

Another parameter is HRT which is given by:

$$\text{HRT} = \frac{\text{Reactor volume, m}^3}{\text{Flow rate, m}^3/\text{h}}$$

= 8 to 10 h or more at average flow.

The reactor volume has to be so chosen that the desired SRT value is achieved. This is done by solving for HRT from SRT equation assuming (i) depth of reactor (ii) the effective depth of the sludge blanket, and (iii) the average concentration of sludge in the blanket (70 kg/m<sup>3</sup>). The full depth of the reactor for treating low BOD municipal sewage is often 4.5 to 5.0 m of which the sludge blanket itself may be 2.0 to 2.5 m depth. For high BOD wastes, the depth of both the sludge blanket and the reactor may have to be increased so that the organic loading on solids may be kept within the prescribed range.

Once the size of the reactor is fixed, the upflow velocity can be determined from

$$\text{Upflow velocity m/h} = \frac{\text{Reactor height}}{\text{HRT, h}}$$

Using average flow rate one gets the average HRT while the peak flow rate gives the minimum HRT at which minimum exposure to treatment occurs. In order to retain any flocculent sludge in reactor at all times, experience has shown that the upflow velocity should not be more than 0.5 m/h at average flow and not more than 1.2 m/h at peak flow. At higher velocities, carry over of solids might occur and effluent quality may be deteriorated. The feed inlet system is next designed so that the required length and width of the UASB reactor are determined.

The settling compartment is formed by the sloping hoods for gas collection. The depth of the compartment is 2.0 to 2.5 m and the surface overflow rate kept at 20 to 28 m<sup>3</sup>/m<sup>2</sup>-day (1 to 1.2 m/h) at peak flow. The flow velocity through the aperture connecting the reaction zone with the settling compartment is limited to not more than 5 m/h at peak flow. Due attention has to be paid to the geometry of the unit and to its hydraulics to ensure proper working of the "Gas-Liquid-Solid-Separator (GLSS)" the gas collection hood, the incoming flow distribution to get spatial uniformity and the outflowing effluent.

### **Physical Parameters**

A single module can handle 10 to 15 MLD of sewage. For large flows a number of modules could be provided. Some physical details of a typical UASB reactor module are given below:

Reactor configuration	Rectangular or circular. Rectangular shape is preferred
Depth	4.5 to 5.0 m for sewage.
Width or diameter	To limit lengths of inlet laterals to around 10-12 m for facilitating uniform flow distribution and sludge withdrawal.
Length	As necessary.
Inlet feed	gravity feed from top (preferred for municipal sewage) or pumped feed from bottom through manifold and laterals (preferred in case of soluble industrial wastewaters).
Sludge blanket depth	2 to 2.5 m for sewage. More depth is needed for stronger wastes.
Deflector/GLSS	This is a deflector beam which together with the gas hood (slope 60) forms a "gas-liquid-solid-separator" (GLSS) letting the gas go to the gas collection channel at top, while the liquid rises into the settler compartment and the sludge solids fall back into the sludge compartment. The flow velocity through the aperture connecting the reaction zone with the settling compartment is generally limited to about 5m/h at peak flow.
Settler compartment	2.0-2.5 m in depth. Surface overflow rate equals 20-28 m <sup>3</sup> /m <sup>2</sup> /d at peak flow.

### **Process Design Parameters**

A few process design parameters for UASBs are listed below for municipal sewages with BOD about 200-300 mg/l and temperatures above 20°C.

HRT	8-10 hours at average flow (minimum 4 hours at peak flow)
SRT	30-50 days or more
Sludge blanket concentration (average)	15-30 kg VSS per m <sup>3</sup> . About 70 kg TSS per m <sup>3</sup> .
Organic loading on sludge blanket	0.3-1.0 kg COD/kg VSS day (even upto 10 kg COD/kg VSS day for agro-industrial wastes).
Volumetric organic loading	1-3 kg COD/m <sup>3</sup> day for domestic sewage (10-15 kg COD/m <sup>3</sup> day for agro-industrial wastes)
BOD/COD removal efficiency	Sewage 75-85% for BOD. 74-78% for COD.
Inlet points	Minimum 1 point per 3.7-4.0 m <sup>2</sup> floor area.
Flow regime	Either constant rate for pumped inflows or typically

	fluctuating flows for gravity systems.
Upflow velocity	About 0.5 m/h at average flow, or 1.2 m/h at peak flow, whichever is low.
Sludge production	0.15-0.25 kg TS per m <sup>3</sup> sewage treated.
Sludge drying time	Seven days (in India)
Gas production	Theoretical 0.38 m <sup>3</sup> /kg COD removed. Actual 0.1-0.3 m <sup>3</sup> per kg COD removed.
Gas utilization	Method of use is optional. 1 m <sup>3</sup> biogas with 75% methane content is equivalent to 1.4 kWh electricity.
Nutrients nitrogen and phosphorus removal	5 to 10% only.

## LECTURE-24

### Nitrification-Denitrification Systems

A certain amount of nitrogen removal (20-30%) occurs in conventional activated sludge systems. Nitrogen removal ranging from 70 to 90 % can be obtained by use of nitrification-denitrification method in plants based on activated sludge and other suspended growth systems. Biological denitrification requires prior nitrification of all ammonia and organic nitrogen in the incoming waste.

### Nitrification

There are two groups of chemoautotrophic bacteria that can be associated with the process of nitrification. One group (*Nitrosomonas*) derives its energy through the oxidation of ammonium to nitrite, whereas the other group (*Nitrobacter*) obtains energy through the oxidation of nitrite to nitrate. Both the groups, collectively called *Nitrifiers*, obtain carbon required, from inorganic carbon forms. Nitrification of ammonia to nitrate is a two step process:

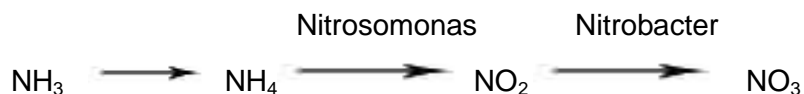

Stoichiometrically, 4.6 kg of oxygen is required for nitrifying 1 kg of nitrogen. Under steady state conditions, experimental evidence has shown nitrite accumulation to be insignificant. This suggests that the rate-limiting step for the conversion of ammonium to nitrate is the oxidation of ammonium to nitrite by the genus *Nitrosomonas*.

### Combined and Separate Systems of Biological Oxidation & Nitrification

Following figure shows flow sheets for combined and separate systems for biological oxidation and nitrification.

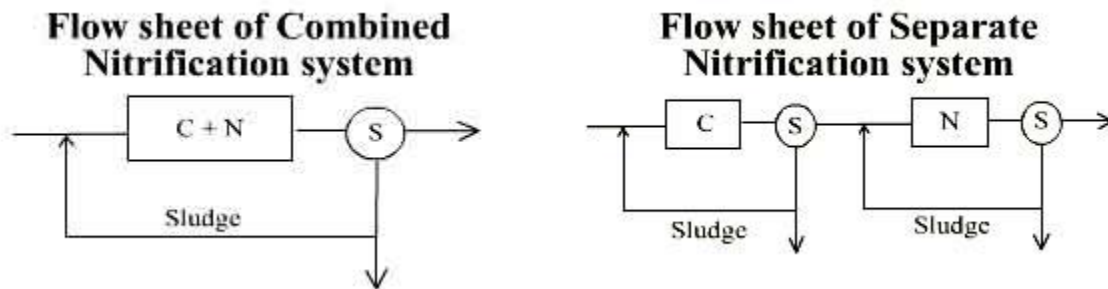

**Combined system** is favoured method of operation as it is less sensitive to load variations - owing to larger sized aeration tank - generally produces a smaller volume of surplus sludge owing to higher values of  $\mu_c$  adopted, and better sludge settleability.

Care should be taken to ensure that the oxygenation capacity of aeration tank is sufficient to meet oxygen uptake due to carbonaceous demand and nitrification. Recycling of sludge must be rapid enough to prevent denitrification (and rising sludge) owing to anoxic conditions in the settling tank.

In **separate system**, the first tank can be smaller in size since a higher F/M ratio can be used, but this makes the system somewhat more sensitive to load variations and also tends to produce more sludge for disposal. An additional settling tank is also necessary between the two aeration tanks to keep the two sludges separate. A principal advantage of this system is its higher efficiency of nitrification and its better performance when toxic substances are feared to be in the inflow.

### . Biological Denitrification

When a treatment plant discharges into receiving stream with low available nitrogen concentration and with a flow much larger than the effluent, the presence of nitrate in the effluent generally does not adversely affect stream quality. However, if the nitrate concentration in the stream is significant, it may be desirable to control the nitrogen content of the effluent, as highly nitrified effluents can still accelerate algal blooms. Even more critical is the case where treatment plant effluent is discharged directly into relatively still bodies of water such as lakes or reservoirs. Another argument for the control of nitrogen in the aquatic environment is the occurrence of infantile methemoglobinemia, which results from high concentration of nitrates in drinking water.

The four basic processes that are used are: (1) ammonia stripping, (2) selective ion exchange, (3) break point chlorination, and (4) biological nitrification/denitrification.

**Biological nitrification/denitrification** is a two step process. The first step is nitrification, which is conversion of ammonia to nitrate through the action of nitrifying bacteria. The second step is

nitrate conversion (denitrification), which is carried out by facultative heterotrophic bacteria under anoxic conditions.

### **Microbiological Aspects of Denitrification**

- Nitrate conversion takes place through both assimilatory and dissimilatory cellular functions. In ***assimilatory denitrification***, nitrate is reduced to ammonia, which then serves as a nitrogen source for cell synthesis. Thus, nitrogen is removed from the liquid stream by incorporating it into cytoplasmic material.
- In ***dissimilatory denitrification***, nitrate serves as the electron acceptor in energy metabolism and is converted to various gaseous end products but principally molecular nitrogen,  $N_2$ , which is then stripped from the liquid stream.
- Because the microbial yield under anoxic conditions is considerably lower than under aerobic conditions, a relatively small fraction of the nitrogen is removed through assimilation. Dissimilatory denitrification is, therefore, the primary means by which nitrogen removal is achieved.
- A carbon source is also essential as electron donor for denitrification to take place. This source may be in the form of carbon internally available in sewage or artificially added (eg. as methanol). Since most community wastewaters have a higher ratio of BOD:N, the internally available carbon becomes attractive and economical for denitrification.

Denitrification releases nitrogen which escapes as an inert gas to the atmosphere while oxygen released stays dissolved in the liquid and thus reduces the oxygen input needed into the system. Each molecule of nitrogen needs 4 molecules of oxygen during nitrification but releases back 2.5 molecules in denitrification. Thus, theoretically, 62.5% of the oxygen used is released back in denitrification.

### **Typical Flowsheets for Denitrification**

Denitrification in suspended growth systems can be achieved using anyone of the typical flowsheets shown in the figure.

- The use of methanol or any other artificial carbon source should be avoided as far as possible since it adds to the cost of treatment and also some operating difficulties may arise from dosing rate of methanol. Too much would introduce an unnecessary BOD in the effluent while too little would leave some nitrates undernitrified.
- A more satisfactory arrangement would be to use the carbon contained in the waste itself. However, the anoxic tank has to be of sufficient detention time for denitrification to occur which, has a slower rate; since the corresponding oxygen uptake rate of the mixed liquor is mainly due to endogenous respiration and is thus low. The denitrification rate, therefore, in a way also depends on the F/M ratio in the prior aeration tank.
- Consequently, if desired, a portion of the raw waste may be bypassed to enter directly into the anoxic tank and thus contribute to an increased respiration rate. This reduces

the sizes of both the anoxic and aeration tanks, but the denitrification efficiency is reduced as the bypassed unnitrified ammonia can not be denitrified.

- By reversing the relative positions of anoxic and aerobic tanks, the oxygen requirement of the waste in its anoxic state is met by the release of oxygen from nitrates in the recycled flow taken from the end of nitrification tank. Primary settling of the raw waste may be omitted so as to bring more carbon into the anoxic tank.
- More complete nitrification-denitrification can be achieved by Bardenpho arrangement. The first anoxic tank has the advantage of higher denitrification rate while the nitrates remaining in the liquor passing out of the tank can be denitrified further in a second anoxic tank through endogenous respiration.
- The flow from anoxic tank is desirable to reaerate for 10-15 minutes to drive off nitrogen gas bubbles and add oxygen prior to sedimentation.

**Flow sheet for Separate Denitrification of Nitrified Wastewater Using Methanol**

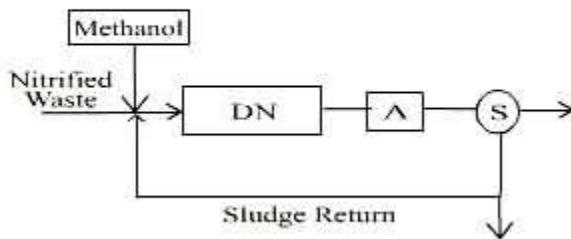

**Separate Denitrification of Nitrified Wastewater Using Methanol**

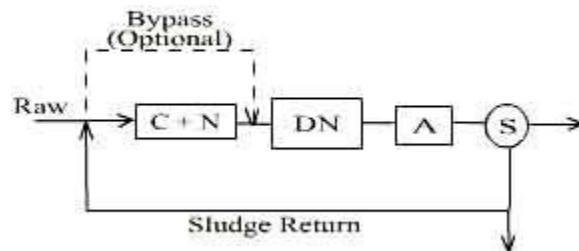

**Pre-denitrification with Recycle of Nitrified Effluent to Anoxic Tank**

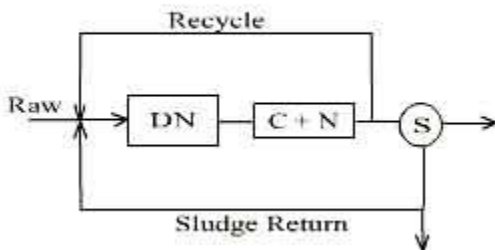

**"Bardenpho" Arrangement With two Anoxic Tanks to Give Higher Degree of Denitrification**

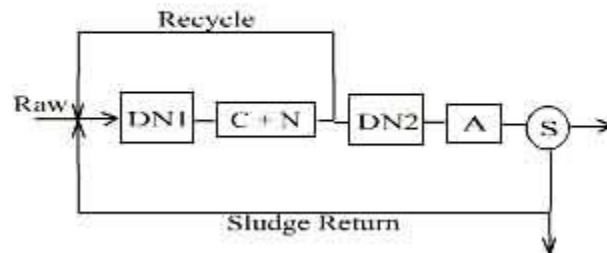



### Simultaneous Nitrification-denitrification in the same Tank

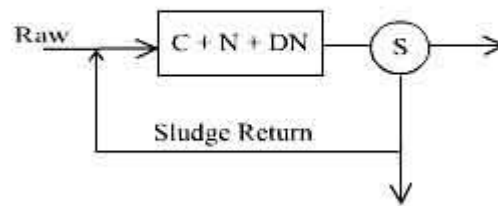

### Removal

Phosphorus precipitation is usually achieved by addition of chemicals like calcium hydroxide, ferrous or ferric chloride, or alum, either in the primary or the final settling tank.

Alum is more expensive and generates more hydroxide, which creates extra sludge, that is difficult to dewater. Use of lime results in an increase of approximately 50% in surplus sludge, but the sludge is reported to have good dewatering properties. When using iron salts, a molar ratio of 1.0:1.4 of iron to phosphorus is reported to give 91-96% removal of total phosphorus using ferrous chloride dosed directly beneath the aerator.

Chemical addition prior to biological treatment is feasible if a primary settling tank exists as in the case of the conventional activated sludge process. The dose requirement then increases, but chemical precipitation also improves organic removal, thus reducing BOD load on the biological treatment. For extended aeration plants there is no primary settling; chemical addition has to be done in the final settling tank.

## LECTURE-25

### Residual Management

In all biological waste treatment processes some surplus sludge is produced. The **objective of residual management** is:

- Reduction of water content.
- Stabilization of sludge solids.
- Reduction in sludge solids volume.

In facultative type **aerated lagoons** and algal **waste stabilization ponds**, the surplus sludge settles out in the unit itself and is removed only once in a few years after emptying the unit, exposing the wet sludge to natural drying, and carting away the dried sludge for agricultural use or land filling.

In **extended aeration process** where aerobic digestion of surplus sludge is done, the sludge can be taken directly for dewatering and disposal.

In case of **activated sludge** and **trickling filter** plants, the sludge is taken (along with the primary sludge) to a sludge digester for further demineralization and thereafter it is dewatered.

### **Sludge Dewatering Methods**

- Natural: sludge drying beds, sludge lagoons
- Mechanical: sludge thickeners, centrifuges, vacuum filters, filter press
- Physical: heat drying, incineration

### **Disposal of Sludge**

Final disposal of sludge is to land and sometimes to the sea, in one of the following ways:

- Agricultural use of dried or wet sludge.
- Use of dried sludge as landfill in absence of agricultural demand.
- Spreading wet sludge on eroded or waste land, contouring the field, so as to gradually build up a top soil of agricultural value.
- Disposing off wet sludge along with solid wastes for (i) composting, or (ii) sanitary landfill.
- Transporting and dumping into the sea.

### **Sludge Characteristics**

For the rational design of sludge drying systems, it is essential to know a few characteristics of sludges, such as moisture content as affected by the nature and extent of organic and other matter contained in them, their specific gravity, weight and volume relationships, their dewatering characteristics, etc. The specific gravity of sludge is very close to that of water itself, 1.01 for biological sludge and 1.02 from alum sludge.

#### ***Stepwise reduction in moisture content in dewatering extended aeration sludge***

Sludge source	Moisture content	Weight, g/person-day		
		% by weight	Solids	Water
Initial moisture content	99	30	2970	3000
After thickening	96	30	720	750
After other mechanical process	90	30	270	300
After natural or physical drying	60	30	45	75

It is evident that the bulk of the water is removed in the thickener. Thereafter, the bulk of the remaining moisture is removed in free drainage. Evaporation removes the least but, in fact,

takes the longest time. The final "dried" sludge still has considerable moisture in it, but the sludge is now "handleable".

### Sand Beds for Sludge Drying

Sand beds are generally constructed as shown in the typical cross-sectional view.

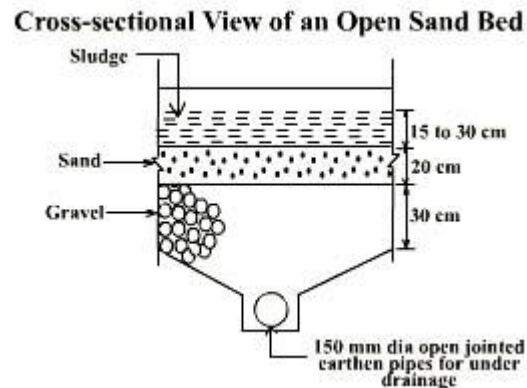

Sludge is generally spread over the sand which is supported on a gravel bed, through which is laid an open-joint earthen pipe 15 cm in diameter spaced about 3 m apart and sloping at a gradient of 1 in 150 towards the filtrate sump. The drying beds are often subdivided into smaller units, each bed 5-8 m wide and 15-50 m long. The drying time averages about 1-2 weeks in warmer climates, and 3-6 or even more in unfavourable ones.

## LECTURE-26

### Sludge Digestion

Sludge digestion involves the treatment of highly concentrated organic wastes in the absence of oxygen by anaerobic bacteria. The anaerobic treatment of organic wastes resulting in the production of carbon dioxide and methane, involves two distinct stages. In the first stage, referred to as "**acid fermentation**", complex waste components, including fats, proteins, and polysaccharides are first hydrolyzed by a heterogeneous group of facultative and anaerobic bacteria. These bacteria then subject the products of hydrolysis to fermentations,  $\beta$ -oxidations, and other metabolic processes leading to the formation of simple organic compounds, mainly short-chain (volatile) acids and alcohols. However in the second stage, referred to as "**methane fermentation**", the end products of the first stage are converted to gases (mainly methane and carbon dioxide) by several different species of strictly anaerobic bacteria.

The bacteria responsible for acid fermentation are relatively tolerant to changes in pH and temperature and have a much higher rate of growth than the bacteria responsible for methane fermentation. If the pH drops below 6.0, methane formation essentially ceases, and more acid accumulates, thus bringing the digestion process to a standstill. As a result, methane fermentation is generally assumed to be the rate limiting step in anaerobic wastewater

treatment. The methane bacteria are highly active in mesophilic (27-43°C) with digestion period of four weeks and thermophilic range (35-40°C) with digestion period of 15-18 days. But thermophilic range is not practised because of odour and operational difficulties.

### **Digestion Tanks or Digesters**

A sludge digestion tank is a RCC or steel tank of cylindrical shape with hopper bottom and is covered with fixed or floating type of roofs.

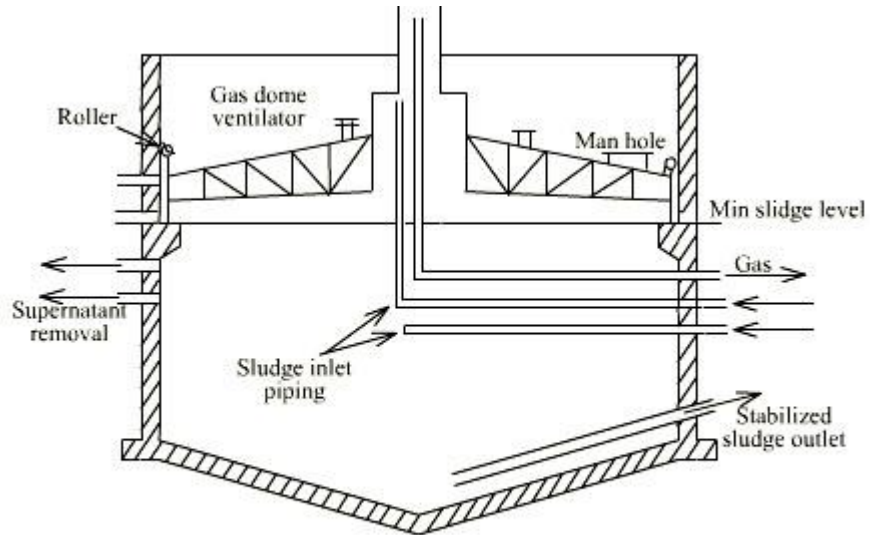

**Anaerobic sludge digester**

### **Types of Anaerobic Digesters**

The anaerobic digesters are of two types: standard rate and high rate. In the standard rate digestion process, the digester contents are usually unheated and unmixed. The digestion period may vary from 30 to 60 d. In a high rate digestion process, the digester contents are heated and completely mixed. The required detention period is 10 to 20 d.

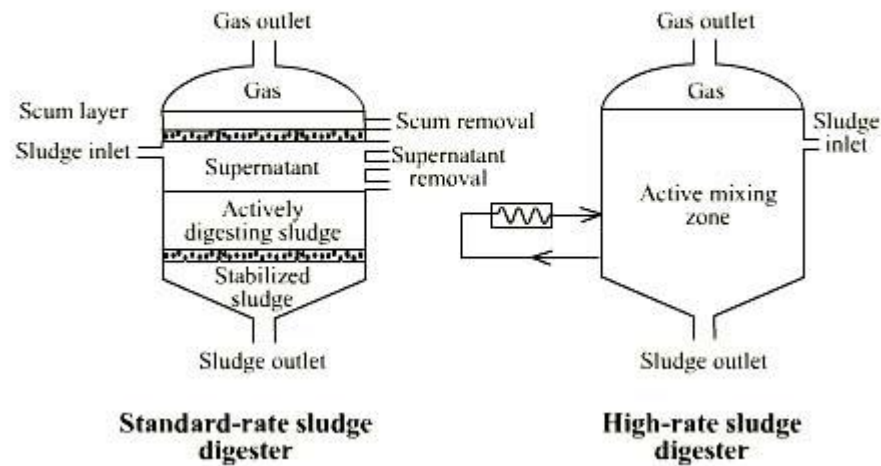

Often a combination of standard and high rate digestion is achieved in two-stage digestion. The second stage digester mainly separates the digested solids from the supernatant liquor: although additional digestion and gas recovery may also be achieved.

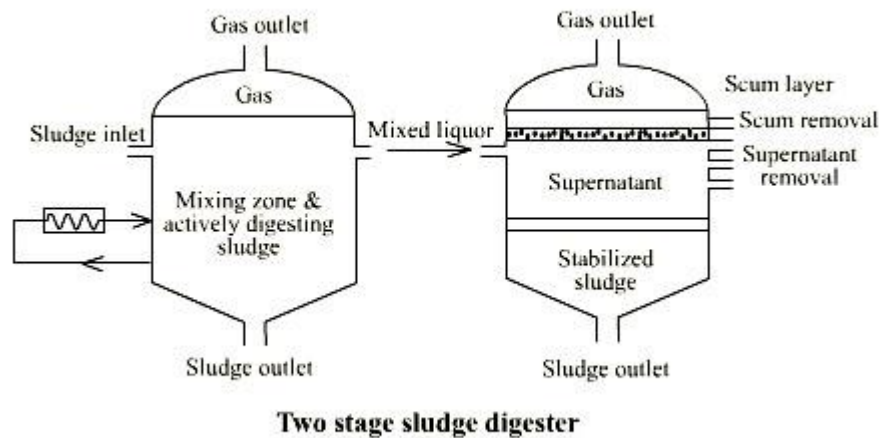

### Design Details

Generally digesters are designed to treat for a capacity upto 4 MLD.

1. Tank sizes are not less than 6 m diameter and not more than 55 m diameter.
2. Liquid depth may be 4.5 to 6 m and not greater than 9 m.
3. The digester capacity may be determined from the relationship

$$V = [V_f - 2/3 (V_f - V_d)]t_1 + V_d t_2$$

where  $V$  = capacity of digester in  $m^3$ ,  $V_f$  = volume of fresh sludge  $m^3/d$ ,  $V_d$  = volume of daily digested sludge accumulation in tank  $m^3/d$ ,  $t_1$  = digestion time in days required for digestion,  $d$ , and  $t_2$  = period of digested sludge storage.

### **Gas Collection**

The amount of sludge gas produced varies from 0.014 to 0.028  $m^3$  per capita. The sludge gas is normally composed of 65% methane and 30% carbondioxide and remaining 5% of nitrogen and other inert gases, with a calorific value of 5400 to 5850  $kcal/m^3$ .

### **Treatment Plant Layout and Siting**

**Plant layout** is the arrangement of designed treatment units on the selected site. The components that need to be included in a treatment plant, should be so laid out as to optimize land requirement, minimize lengths of interconnecting pipes and pumping heads. Access for sludge and chemicals transporting, and for possible repairs, should be provided in the layout.

**Siting** is the selection of site for treatment plant based on features as character, topography, and shoreline. Site development should take the advantage of the existing site topography. The following principles are important to consider:

1. A site on a side-hill can facilitate gravity flow that will reduce pumping requirements and locate normal sequence of units without excessive excavation or fill.
2. When landscaping is utilized it should reflect the character of the surrounding area. Site development should alter existing naturally stabilized site contours and drainage as little as possible.
3. The developed site should be compatible with the existing land uses and the comprehensive development plan.

## **LECTURE-27**

### **Treatment Plant Hydraulics**

**Hydraulic profile** is the graphical representation of the hydraulic grade line through the treatment plant. If the high water level in the receiving water is known, this level is used as a control point, and the head loss computations are started backward through the plant. The **total available head** at the treatment plant is the difference in water surface elevations in the interceptor and the water surface elevation in the receiving water at high flood level. If the total available head is less than the head loss through the plant, flow by gravity cannot be achieved. In such cases pumping is needed to raise the head so that flow by gravity can occur.

There are many basic principles that must be considered when preparing the hydraulic profile through the plant. Some are listed below:

1. The hydraulic profiles are prepared at peak and average design flows and at minimum initial flow.
2. The hydraulic profile is generally prepared for all main paths of flow through the plant.
3. The head loss through the treatment plant is the sum of head losses in the treatment units and the connecting piping and appurtenances.
4. The head losses through the treatment unit include the following:
  - a. Head losses at the influent structure.
  - b. Head losses at the effluent structure.
  - c. Head losses through the unit.
  - d. Miscellaneous and free fall surface allowance.
5. The total loss through the connecting pipings, channels and appurtenances is the sum of following:
  - a. Head loss due to entrance.
  - b. Head loss due to exit.
  - c. Head loss due to contraction and enlargement.
  - d. Head loss due to friction.
  - e. Head loss due to bends, fittings, gates, valves, and meters.
  - f. Head required over weir and other hydraulic controls.
  - g. Free-fall surface allowance.

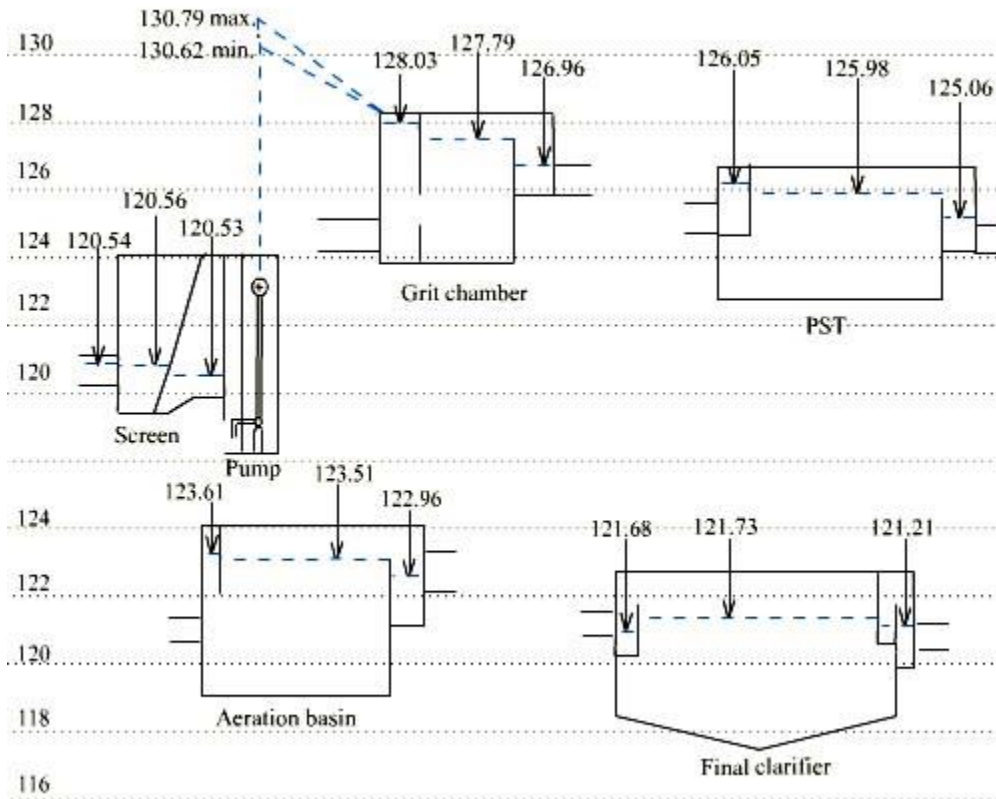

## LECTURE-28

### Treated Effluent Disposal

The proper disposal of treatment plant effluent or reuse requirements is an essential part of planning and designing wastewater treatment facilities. Different methods of ultimate disposal of secondary effluents are discussed as follows.

### Natural Evaporation

The process involves large impoundments with no discharge. Depending on the climatic conditions large impoundments may be necessary if precipitation exceeds evaporation. Therefore, considerations must be given to net evaporation, storage requirements, and possible percolation and groundwater pollution. This method is particularly beneficial where recovery of residues is desirable such as for disposal of brines.

### Groundwater Recharge

Methods for groundwater recharge include rapid infiltration by effluent application or impoundment, intermittent percolation, and direct injection. In all cases risks for groundwater



pollution exists. Furthermore, direct injection implies high costs of treating effluent and injection facilities.

### **Irrigation**

Irrigation has been practiced primarily as a substitute for scarce natural waters or sparse rainfall in arid areas. In most cases food chain crops (i.e. crops consumed by humans and those animals whose products are consumed by humans) may not be irrigated by effluent. However, field crops such as cotton, sugar beets, and crops for seed production are grown with wastewater effluent.

Wastewater effluent has been used for watering parks, golf courses and highway medians.

### **Recreational Lakes**

The effluent from the secondary treatment facility is stored in a lagoon for approximately 30 days. The effluent from the lagoon is chlorinated and then percolated through an area of sand and gravel, through which it travels for approximately 0.5 km and is collected in an interceptor trench. It is discharged into a series of lakes used for swimming, boating and fishing.

### **Aquaculture**

Aquaculture, or the production of aquatic organisms (both flora and fauna), has been practiced for centuries primarily for production of food, fiber and fertilizer. Lagoons are used for aquaculture, although artificial and natural wetlands are also being considered. However, the uncontrolled spread of water hyacinths is itself a great concern because the flora can clog waterways and ruin water bodies.

### **Municipal Uses**

Technology is now available to treat wastewater to the extent that it will meet drinking water quality standards. However, direct reuse of treated wastewater is practicable only on an emergency basis. Many natural bodies of water that are used for municipal water supply are also used for effluent disposal which is done to supplement the natural water resources by reusing the effluent many times before it finally flows to the sea.

### **Industrial Uses**

Effluent has been successfully used as a cooling water or boiler feed water. Deciding factors for effluent reuse by the industry include (1) availability of natural water, (2) quality and quantity of effluent, and cost of processing, (3) pumping and transport cost of effluent, and (4) industrial process water that does not involve public health considerations.

### **Discharge into Natural Waters**

Discharge into natural waters is the most common disposal practice. The self-purification or assimilative capacity of natural waters is thus utilized to provide the remaining treatment.

### **Stabilization Ponds**

- The **stabilization ponds** are open flow through basins specifically designed and constructed to treat sewage and biodegradable industrial wastes. They provide long detention periods extending from a few to several days.
- Pond systems, in which oxygen is provided through mechanical aeration rather than algal photosynthesis are called *aerated lagoons*.
- Lightly loaded ponds used as tertiary step in waste treatment for polishing of secondary effluents and removal of bacteria are called **maturation ponds**.

### **Classification of Stabilization Ponds**

Stabilization ponds may be aerobic, anaerobic or facultative.

- **Aerobic ponds** are shallow ponds with depth less than 0.5 m and BOD loading of 40-120 kg/ha.d so as to maximize penetration of light throughout the liquid depth. Such ponds develop intense algal growth.
- **Anaerobic ponds** are used as pretreatment of high strength wastes with BOD load of 400-3000 kg/ha.d Such ponds are constructed with a depth of 2.5-5m as light penetration is unimportant.
- **Facultative pond** functions aerobically at the surface while anaerobic conditions prevail at the bottom. They are often about 1 to 2 m in depth. The aerobic layer acts as a good check against odour evolution from the pond.

### **Mechanism of Purification**

The functioning of a facultative stabilization pond and symbiotic relationship in the pond are shown below. Sewage organics are stabilized by both aerobic and anaerobic reactions. In the top aerobic layer, where oxygen is supplied through algal photosynthesis, the non-settleable and dissolved organic matter is oxidized to CO<sub>2</sub> and water. In addition, some of the end products of partial anaerobic decomposition such as volatile acids and alcohols, which may permeate to upper layers are also oxidized periodically. The settled sludge mass originating from raw waste and microbial synthesis in the aerobic layer and dissolved and suspended organics in the lower layers undergo stabilization through conversion to methane which escapes the pond in form of bubbles.

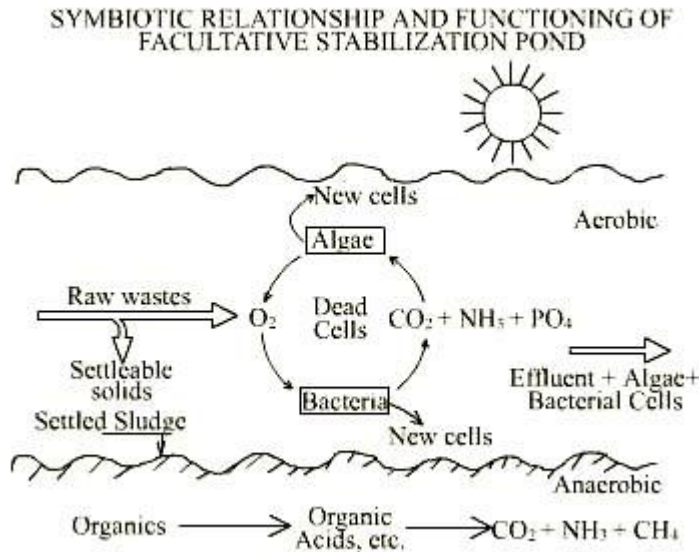

## LECTURE-29

### Factors Affecting Pond Reactions

Various factors affect pond design:

- wastewater characteristics and fluctuations.
- environmental factors (solar radiation, light, temperature)
- algal growth patterns and their diurnal and seasonal variation)
- bacterial growth patterns and decay rates.
- solids settlement, gasification, upward diffusion, sludge accumulation.

The depth of aerobic layer in a facultative pond is a function of solar radiation, waste characteristics, loading and temperature. As the organic loading is increased, oxygen production by algae falls short of the oxygen requirement and the depth of aerobic layer decreases. Further, there is a decrease in the photosynthetic activity of algae because of greater turbidity and inhibitory effect of higher concentration of organic matter.

Gasification of organic matter to methane is carried out in distinct steps of acid production by acid forming bacteria and acid utilization by methane bacteria. If the second step does not proceed satisfactorily, there is an accumulation of organic acids resulting in decrease of pH which would result in complete inhibition of methane bacteria. Two possible reasons for imbalance between activities of methane bacteria are: (1) the waste may contain inhibitory substances which would retard the activity of methane bacteria and not affect the activity of acid producers to the same extent. (2) The activity of methane bacteria decreases much more rapidly with fall in temperature as compared to the acid formers.

Thus, year round warm temperature and sunshine provide an ideal environment for operation of facultative ponds.

### **Algal Growth and Oxygen Production**

Algal growth converts solar energy to chemical energy in the organic form. Empirical studies have shown that generally about 6% of visible light energy can be converted to algal energy.

The chemical energy contained in an algal cell averages 6000 calories per gram of algae.

Depending on the sky clearance factor for an area, the average visible radiation received can be estimated as follows:

$$\text{Avg. radiation} = \text{Min. radiation} + [(\text{Max. radiation} - \text{Min. radiation}) \times \text{sky clearance factor}]$$

Oxygen production occurs concurrently with algal production in accordance with following equation:



On weight basis, the oxygen production is 1.3 times the algal production.

### **Areal Organic Loading**

The permissible areal organic loading for the pond expressed as kg BOD/ha.d will depend on the minimum incidence of sunlight that can be expected at a location and also on the percentage of influent BOD that would have to be satisfied aerobically. The Bureau of Indian Standards has related the permissible loading to the latitude of the pond location to aerobically stabilize the organic matter and keep the pond odour free. The values are applicable to towns at sea levels and where sky is clear for nearly 75% of the days in a year. The values may be modified for elevations above sea level by dividing by a factor  $(1 + 0.003 \text{ EL})$  where EL is the elevation of the pond site above MSL in hundred meters.

### **Detention Time**

The flow of sewage can approximate either plug flow or complete mixing or dispersed flow. If BOD exertion is described by first order reaction, the pond efficiency is given by:

$$\text{for plug flow: } L_0/L_i = e^{-k_1 t}$$

$$\text{for complete mixing: } L_0/L_i = \frac{1}{1+k_1 t}$$

For dispersed flow the efficiency of treatment for different degrees of intermixing is characterized by dispersion numbers. Choice of a larger value for dispersion number or assumption of complete mixing would give a conservative design and is recommended.

### Depth

Having determined the surface area and detention capacity, it becomes necessary to consider the depth of the pond only in regard to its limiting value. The optimum range of depth for facultative ponds is 1.0 - 1.5 m.

### Aquatic Plant Systems

Aquatic systems in waste treatment are either free floating growths harnessed in the form of built-up ponds for waste treatment such as **duckweed and hyacinth ponds** or rooted vegetations (reeds) which emerge out of shallow waters cultivated in **constructed wetlands**.

- **Natural wetlands** exist all over the world. They generally have saturated soil conditions and abound in rooted vegetation which emerges out of shallow waters in the euphotic zone. They may also have phytoplankton. Natural wetlands can be integrated with wastewater treatment systems.
- **Constructed wetlands** are man-made for treatment of wastewater, mine drainage, storm drainage, etc. They have rooted vegetation.

### **Longitudinal Section Through a Typical Reed Bed With Gravel, Sand or Selected Soil With Horizontal Flow of Wastewater**

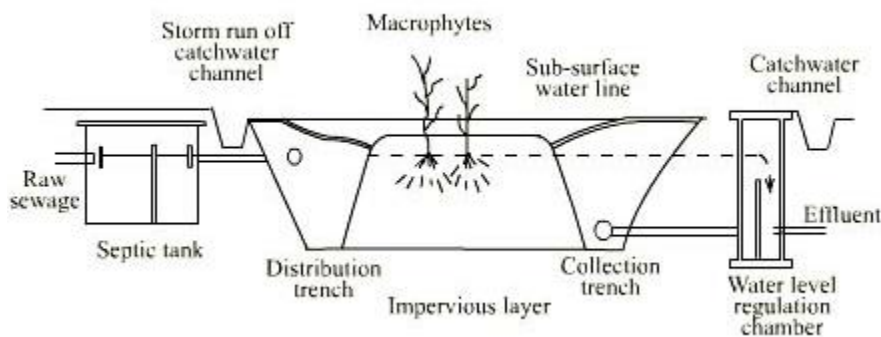

- **Aquatic plant ponds** consisting of free floating macrophytes, such as water hyacinths, duckweeds, etc. have been cultured in ponds either for their ability to remove heavy metals, phenols, nutrients, etc. from wastewaters or to assist in giving further treatment to pretreated wastewaters to meet stringent discharge standards while at the same time producing new plant growths for their gas production or food value.

## Conceptual flowsheet showing waste treatment using an aquatic plant pond

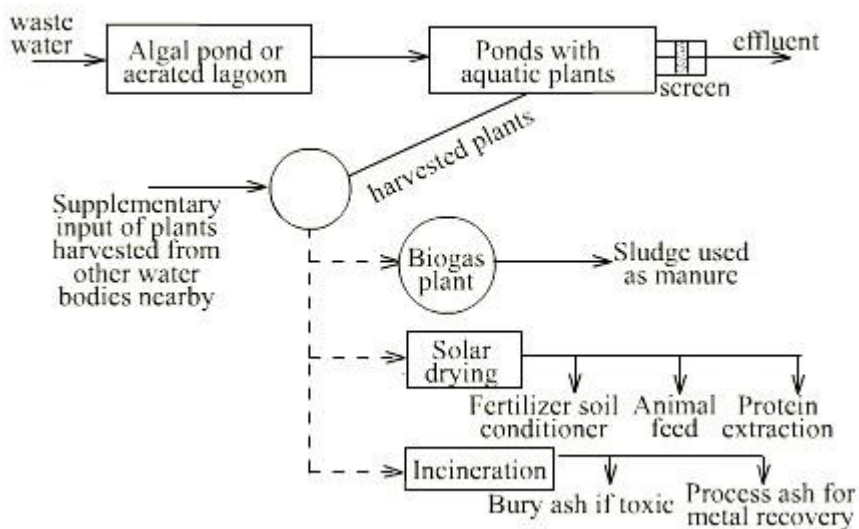

## LECTURE-30

### Septic Tank

Septic tanks are horizontal continuous flow, small sedimentation tanks through which sewage is allowed to flow slowly to enable the sewage solids to settle to the bottom of the tank, where they are digested anaerobically. The tank is de-sludged at regular intervals usually once every 1-5 years.

### Cesspool

It is a pit excavated in soil with water tight lining and loose lining by stone or brick to provide for leaching of wastewater by sides and the pit is covered. The leaching type is suitable for porous soils. The capacity should not be less than one day's flow into the pit. If all the water in a test pit of one meter diameter and 2 m deep, disappears in 24 hours, such soil is best suitable for cesspools. The bottom of the cesspool must be well above the ground water level. After sometime the sides of pit get clogged by the sewage solids, reducing the leaching capacity. At overflow level, an outlet is provided to take-off unleached liquid into a seepage pit. The settled matter is removed at intervals. Water tight cesspools are cleaned every 6 months and their capacity must not be less than 70 l/person/month.

### Seepage Pit

The seepage pit is needed to discharge the effluent of cesspool, aquaprivy, septic tank or sullage from bathrooms and kitchens. The difference between seepage pit and cesspool is that the seepage pit is completely filled up with stones. The fine suspended solids adhere to the

surface of stones and get decomposed by the zooglear film, which are on the stones and the effluent is leached into the sidewalls.

## LECTURE-31

### Module-IV

#### Air pollution

##### Unit of measurement

Concentrations of air pollutants are commonly expressed as the mass of pollutant per unit volume of air mixture, as  $\text{mg/m}^3$ ,  $\mu\text{g/m}^3$ ,  $\text{ng/m}^3$

Concentration of gaseous pollutants may also be expressed as volume of pollutant per million volumes of the air plus pollutant mixture (ppm) where  $1\text{ppm} = 0.0001\%$  by volume. It is sometimes necessary to convert from volumetric units to mass per unit volume and vice versa.

The relationship between ppm and  $\text{mg/m}^3$  depends on the gas density, which in turn depends on: <sup>TM</sup>Temperature, Pressure, Molecular weight of the pollutant

The following expression can be used to convert between ppm and  $\text{mg/m}^3$  at any temperature or pressure.

$$\text{mg/m}^3 = \frac{273 \times \text{PPM} \times \text{molecular wt.} \times \text{pressure}}{22.4 \times \text{temperature}}$$

Simply multiply the calculated value of  $\text{mg/m}^3$  by 1000 to obtain  $\mu\text{g/m}^3$ . The constant 22.4 is the volume in liter occupied by 1 mole of an ideal gas at standard concentration ( $0^\circ\text{C}$  and 1 atm.). One mole of any substance is a quantity of that substance whose mass in grams numerically equals its molecular weight

##### Sources and Classification of pollutants

Air pollution may be defined as any atmospheric condition in which certain substances are present in such concentrations that they can produce undesirable effects on man and his environment. These substances include gases ( $\text{SO}_x$ ,  $\text{NO}_x$ , CO, HCs, etc) particulate matter (smoke, dust, fumes, aerosols) radioactive materials and many others. Most of these substances are naturally present in the atmosphere in low (background) concentrations and are usually considered to be harmless. A particular substance can be considered as an air pollutant only when its concentration is relatively high compared with the background value and causes adverse effects.

Air pollution is a problem of obvious importance in most of the world that affects human, plant and animal health. For example, there is good evidence that the health of 900 million urban people suffers daily because of high levels of ambient air sulfur dioxide concentrations. Air pollution is one of the 6 most serious environmental problems in societies at all levels of



economic development. Air pollution can also affect the properties of materials (such as rubber), visibility, and the quality of life in general. Industrial development has been associated with emission to air of large quantities of gaseous and particulate emissions from both industrial production and from burning fossil fuels for energy and transportation.

When technology was introduced to control air pollution by reducing emissions of particles, it was found that the gaseous emissions continued and caused problems of their own. Currently efforts to control both particulate and gaseous emissions have been partially successful in much of the developed world, but there is recent evidence that air pollution is a health risk even under these relatively favorable conditions.

In societies that are rapidly developing sufficient resources may not be invested in air pollution control because of other economic and social priorities. The rapid expansion of the industry in these countries has occurred at the same time as increasing traffic from automobiles and trucks, increasing demands for power for the home, and concentration of the population in large urban areas called mega cities. The result has been some of the worst air pollution problem in the world.

In many traditional societies, and societies where crude household energy sources are widely available, air pollution is a serious problem because of inefficient and smoky fuels used to heat buildings and cook. This causes air pollution both out door and indoors. The result can be lung disease, eye problems, and increased risk of cancer.

The quality of air indoors is a problem also in many developed countries because buildings were built to be airtight and energy efficient. Chemicals produced by heating and cooling systems, smoking and evaporation from buildings materials accumulate indoors and create a pollution problem.

The health effects of ambient air pollution have been difficult to document with certainty until recent years. This is because of methodological problems in assessing exposure, other factors that cause respiratory disease (such as cigarette smoking, respiratory tract infections, and allergies), and the difficulty of studying such effects in large populations.

Recently, however, a series of highly sophisticated and convincing studies from virtually every continent have demonstrated that air pollution has a major effect on human health. Respiratory symptoms are the most common adverse health effects from air pollution of all types. Following Table presents a summary of major health effects thought to be caused by community air pollution. Respiratory effects of air pollution, particularly complicating chronic bronchitis, may place an additional strain on the heart as well.

Disease or condition	How air pollution may affect it	Associated factors
Eye irritation	Specific effect of photochemical oxidants, Possibly aldehydes or peroxyacetyl Nitrates; particulate matter (fly ash) as a Foreign body	Susceptibility differs
Acute bronchitis	Direct irritative effects of SO <sub>2</sub> , soot and Petrochemical pollution	Cigarette smoking may have a more than Additive interaction
Chronic bronchitis	Aggravation (increase in Frequency or Severity) of cough or sputum Associated with any sort of pollution	Cigarette smoking, occupation
Asthma	Aggravation from respiratory irritation, Possibly on reflex basis	usually pre-existing respiratory allergy or airway hyperactivity
Headache	Carbon monoxide sufficient To lead to more than 10% carboxyhaemoglobin	Smoking may also increase carboxyhaemoglobin but not Enough to lead to headache
Lead toxicity	Add to body burden	Close proximity to lead source; Exposure at home

Air pollution is associated with increased risk of death from heart disease and lung disease, even at levels below those known to be acutely toxic to the heart. Mucosal irritation in the form of acute or chronic bronchitis, nasal tickle, or conjunctivitis is characteristic of high levels of air pollution, although individuals vary considerably in their susceptibility to such effects.

The eye irritation is particularly severe, in the setting of high levels of particulates (which need to be in the respirable range described and may be quite large soot particles) or of high concentrations of photochemical oxidants and especially aldehydes.

There is little evidence to suggest that community air pollution is a significant cause of cancer except in unusual and extreme cases. However, emissions from particular sources may be cancer-causing. Examples of cancer associated with community air pollution may include point-source emissions from some smelters with poor controls that release arsenic, which can cause lung cancer. Central nervous system effects, and possibly learning disabilities in children, may result from accumulated body burdens of lead, where air pollution contributes a large fraction of exposure because of lead additives in gasoline.

These health effects are better characterized for populations than for individual patients. Establishing a relationship between the symptoms of a particular patient and exposure to air pollution is more difficult than interpreting the likely health effects on an entire community. It is important to understand that these pollutants are seasonal in their pattern. Both ozone and sulfates, together with ultra fine particulates, tend to occur together during the summer months in most developed areas. Ozone, oxides of nitrogen, aldehydes, and carbon monoxide tend to

occur together in association with traffic, especially in sunny regions. Some pollutants, such as radon, are only hazards indoors or in a confined area. Others are present both indoors and outdoors, with varying relative concentrations.

### **Classifications of Air Pollutants**

Air pollutants can be classified as

#### **a. Criteria Pollutants**

There are 6 principal, or “criteria” pollutants regulated by the US-EPA and most countries in the world:

- Total suspended particulate matter (TSP), with additional subcategories of particles smaller than 10 µm in diameter (PM10), and particles smaller than 2.5 µm in diameter (PM2.5). PM can exist in solid or liquid form, and includes smoke, dust, aerosols, metallic oxides, and pollen. Sources of PM include combustion, factories, construction, demolition, agricultural activities, motor vehicles, and wood burning. Inhalation of enough PM over time increases the risk of chronic respiratory disease.
- Sulfur dioxide (SO<sub>2</sub>). This compound is colorless, but has a suffocating, pungent odor. The primary source of SO<sub>2</sub> is the combustion of sulfur-containing fuels (e.g., oil and coal). Exposure to SO<sub>2</sub> can cause the irritation of lung tissues and can damage health and materials.
- Nitrogen oxides (NO and NO<sub>2</sub>). NO<sub>2</sub> is a reddish-brown gas with a sharp odor. The primary source of this gas is vehicle traffic, and it plays a role in the formation of tropospheric ozone. Large concentrations can reduce visibility and increase the risk of acute and chronic respiratory disease.
- Carbon monoxide (CO). This odorless, colorless gas is formed from the incomplete combustion of fuels. Thus, the largest source of CO today is motor vehicles. Inhalation of CO reduces the amount of oxygen in the bloodstream, and high concentrations can lead to headaches, dizziness, unconsciousness, and death.
- Ozone (O<sub>3</sub>). Tropospheric (“low-level”) ozone is a secondary pollutant formed when sunlight causes photochemical reactions involving NO<sub>x</sub> and VOCs. Automobiles are the largest source of VOCs necessary for these reactions. Ozone concentrations tend to peak in the afternoon, and can cause eye irritation, aggravation of respiratory diseases, and damage to plants and animals.
- Lead (Pb). The largest source of Pb in the atmosphere has been from leaded gasoline combustion, but with the gradual elimination worldwide of lead in gasoline, air Pb levels have decreased considerably. Other airborne sources include combustion of solid waste, coal, and oils, emissions from iron and steel production and lead smelters, and tobacco smoke. Exposure to Pb can affect the blood, kidneys, and nervous, immune, cardiovascular, and reproductive systems.

## b. Toxic Pollutants

Hazardous air pollutants (HAPS), also called toxic air pollutants or air toxics, are those pollutants that cause or may cause cancer or other serious health effects, such as reproductive effects or birth defects. The US-EPA is required to control 188 hazardous air pollutants

Examples of toxic air pollutants include benzene, which is found in gasoline; perchlorethylene, which is emitted from some dry cleaning facilities; and methylene chloride, which is used as a solvent and paint stripper by a number of industries.

## c. Radioactive Pollutants

Radioactivity is an air pollutant that is both geogenic and anthropogenic. Geogenic radioactivity results from the presence of radionuclides, which originate either from radioactive minerals in the earth's crust or from the interaction of cosmic radiation with atmospheric gases. Anthropogenic radioactive emissions originate from nuclear reactors, the atomic energy industry (mining and processing of reactor fuel), nuclear weapon explosions, and plants that reprocess spent reactor fuel. Since coal contains small quantities of uranium and thorium, these radioactive elements can be emitted into the atmosphere from coal-fired power plants and other sources.

## d. Indoor Pollutants

When a building is not properly ventilated, pollutants can accumulate and reach concentrations greater than those typically found outside. This problem has received media attention as "Sick Building Syndrome". Environmental tobacco smoke (ETS) is one of the main contributors to indoor pollution, as are CO, NO, and SO<sub>2</sub>, which can be emitted from furnaces and stoves. Cleaning or remodeling a house is an activity that can contribute to elevated concentrations of harmful chemicals such as VOCs emitted from household cleaners, paint, and varnishes. Also, when bacteria die, they release endotoxins into the air, which can cause adverse health effects<sup>31</sup>. So ventilation is important when cooking, cleaning, and disinfecting in a building. A geogenic source of indoor air pollution is radon<sup>32</sup>.

## Other classifications

Air pollutants come in the form of **gases** and finely divided **solid** and **liquid** aerosols. *Aerosols* are loosely defined as "any solid or liquid particles suspended in the air" (1).

Air pollutants can also be of *primary* or *secondary* nature. *Primary air pollutants* are the ones that are emitted directly into the atmosphere by the sources (such as power-generating plants).

*Secondary air pollutants* are the ones that are formed as a result of reactions between primary pollutants and other elements in the atmosphere, such as ozone.

## Types of pollutants

### Sulfur Dioxide

Sulfur dioxide was a serious problem in air pollution in the earliest days of industrialization. It has been the major problem in reducing or acidifying air pollution during the period of rapid economic growth in many countries. In 1953, Amdur et al. studied the effects of sulfur dioxide on humans and found that, at least in acute exposures, concentrations of up to 8 ppm caused respiratory changes that were dose dependent. (This is one of the first studies to use physiological measurements as an indication of the effects of air pollution.) Later studies revealed that the main effect of sulfur dioxide is broncho constriction (closing of the airways causing increased resistance to breathing) which is dose dependent, rapid, and tended to peak at 10 minutes (Folinsbee, 1992). Persons with asthma are particularly susceptible and in fact asthmatics suffer more from the effects of sulfur dioxide than does the general public. Persons with asthma who exercise will typically experience symptoms at 0.5 ppm, depending on the individual.

Sulfate, the sulfur-containing ion present in water, remains a major constituent of air pollution capable of forming acid. Sulfate itself appears to be capable of triggering broncho constriction in persons with airways reactivity and it is a major constituent of ultrafine particulates. There are other acid ingredients in air pollution, such as nitric acid, but less is known about them. These acids, though, cause a phenomenon known as acid rain, with their emission into the air by industry and motor vehicles.

Because of their small size and tendency to ride along on particulates, acid aerosols such as sulfur dioxide, sulfates and nitrogen dioxide tend to deposit deeply in the distal lung and airspace. They appear to provoke airways responses in an additive or synergistic manner with ozone. They have also been implicated in causing mortality in association with ultra fine particulates.

SO<sub>2</sub> and sulfates are the principal chemical species that cause acid precipitation. They may be transported long distances in the atmosphere away from their source and result in acidification of water and soils.

### Nitrogen Dioxide

Nitric oxide (NO) is produced by combustion. Nitrogen dioxide (NO<sub>2</sub>), which has greater health effects, is a secondary pollutant created by the oxidation of NO under conditions of sunlight, or may be formed directly by higher temperature combustion in power plants or indoors from gas stoves. Levels of exposure to nitrogen dioxide that should not be exceeded (WHO guideline levels) are respectively 400 µg/m<sup>3</sup> (0.21 parts per million (ppm) for one hour and 150 µg/m<sup>3</sup> (0.08 ppm) for 24 hours.

The direct effects of nitrogen oxide include increased infectious lower respiratory disease in children (including longterm exposure as in houses with gas stoves) and increased asthmatic problems. Extensive studies of the oxides of nitrogen have shown that they impair host defenses in the respiratory tract, increasing the incidence and severity of bacterial infections

after exposure. They have a marked effect in reducing the capacity of the lung to clear particles and bacteria.

NO<sub>2</sub> also provokes broncho-constriction and asthma in much the same way as ozone but it is less potent than ozone in causing asthmatic effects. Despite decades of research, however, the full effects of NO<sub>2</sub> are not known. Known human health effects are summarized below:

<b>Health Effect</b>	<b>Mechanism</b>
Increased incidence of respiratory infections	Reduced efficacy of lung defenses
Increased severity of respiratory infections	Reduced efficacy of lung defenses
Respiratory symptoms	Airways injury
Reduced lung function	Airways and possibly alveolar injury
Worsening of the clinical status of persons with asthma, Chronic obstructive pulmonary diseases or other chronic Respiratory conditions	Airways injury

## LECTURE-32

### Particulates matter

Particle matter in the air (aerosols) is associated with an elevated risk of mortality and morbidity (including cough and bronchitis), especially among populations such as asthmatics and the elderly. As indicated, they are released from fireplaces, wood and coal stoves, tobacco smoke, diesel and automotive exhaust, and other sources of combustion. The US Environmental protection Agency (EPA) sets a standard of 265 µg/m<sup>3</sup> in ambient air, but does not have a standard for indoor air levels. Usual concentrations range from 500 µg/m<sup>3</sup> in bars and waiting rooms to about 50 µg/m<sup>3</sup> in homes. In developed countries, tobacco smoke is the primary contributor to respirable particles indoors.

#### ***Particulate matter (PM 10)***

Larger particulates, which are included in PM<sub>10</sub> (particulates 10 µm and smaller) consist mostly of carbon-containing material and are produced from combustion; some fraction of these are produced by wind blowing soil into the air. These larger particulates do not seem to have as much effect on human health as the smaller particulates.

#### ***Particulate matter (PM 2.5)***

In recent years we have learned a great deal about the health effects of particles. As noted above, particulates in urban air pollution that are extremely small, below 2.5 µm in diameter, are different in their chemical composition than larger particles. Particulates in the fraction PM<sub>2.5</sub>

(2.5  $\mu\text{m}$  and below) contain a proportionately larger amount of water and acid forming chemicals such as sulfate and nitrate, as well as trace metals. These smaller particulates penetrate easily and completely into buildings and are relatively evenly dispersed throughout urban regions where they are produced. Unlike other air contaminants that vary in concentration from place to place within an area, PM<sub>2.5</sub> tends to be rather uniformly distributed.

PM<sub>2.5</sub> sulfate and ozone cannot be easily separated because they tend to occur together in urban air pollution. Recent research strongly suggests that at least PM<sub>2.5</sub> and sulfate, and probably ozone as well, cause an increase in deaths in affected cities. The higher the air pollution levels for these specific contaminants, the more excess deaths seem to occur on any given day, above the levels that would be expected for the weather and the time of year. Likewise, accounting for the time of the year and the weather, there are more hospital admissions for various conditions when these contaminants are high. Ozone, particularly, is linked with episodes of asthma, but all three seem to be associated with higher rates of deaths from and complaints about lung disease and heart disease. It is not yet known which is the predominant factor in the cause of these health effects, and some combination of each may be responsible for some effects. Although the effect of air pollution is clearly present in the statistics, air pollution at levels common in developed countries is probably much less of a factor in deaths and hospital admissions than the weather, cigarette smoking, allergies, and viral infections. However, the populations exposed to air pollution are very large, and even if only 5% of all excess deaths during a one-week period are related to air pollution in a major city, a reasonable estimate, this means that thousands of deaths could be prevented. One unexpected finding of this research is that the effect of particulate air pollution on deaths and hospital admissions is continuous from high levels to low levels of exposure. In other words, there is no obvious level below which the public is clearly protected, and even at low levels of air pollution, some excess deaths still seem to occur. At first, it was thought that these deaths represented sick people who would soon die anyway. If this were true, one would expect there to be fewer deaths than expected when air pollution levels returned to normal or below normal, but a careful study of the death rate during and just after periods of high air pollution levels does not seem to show this. At the much greater levels encountered in many developing countries, the effect is likely to be proportionately greater. There are many factors at work that complicate such studies in developing countries. The very high rates of respiratory disease during the winter among even non smokers in some northern Chinese cities, for example, has been attributed to air pollution and this is likely to be true, however, cigarette smoking, indoor air pollution from coal-fired stoves, crowded conditions and the risk of viral infections may also be important factors.

There remains much more work to do to understand this problem, but the essential message seems clear: at any level, particulate air pollution and possibly ozone are associated with deaths, and both are clearly associated with hospital admissions and health risks.

### Hydrocarbons

Most hydrocarbons such as aliphatic and salicylic hydrocarbons are generally biochemical inert at ambient levels and thus present little hazards. Aromatic hydrocarbon such, on the other hand

are biochemical and biologically active are more irritating to mucous membranes compounds like benzo(a) Pyrene are known to be potent carcinogens. HCs are included among the criteria air pollutants, chiefly because of their role as catalysts in the formation of photochemical smog.

### Lead

Lead is the best studied of these trace metals. It is known to be a highly toxic substance that particularly causes nerve damage. In children, this can result in learning disabilities and neurobehavioral problems. An estimated 80 – 90% of lead in ambient air is thought to be derived from the combustion of leaded petrol. Due to its effects on the behavior and learning abilities of children even at low levels of exposure, efforts throughout the world are directed at removing lead from gasoline. The WHO guidelines value for long-term exposure to lead in the air is 0.5 –1.0  $\mu\text{g}/\text{m}^3$  /year).

### **Influence of meteorological phenomena on air quality**

Meteorology specifies what happens to puff or plume of pollutants from the time it is emitted to the time it is detected at some other location. The motion of the air causes a dilution of air pollutant concentration and we would like to calculate how much dilution occurs as a function of the meteorology or atmospheric condition.

Air pollutants emitted from anthropogenic sources must first be transported and diluted in the atmosphere before these undergo various physical and photochemical transformation and ultimately reach their receptors. Otherwise, the pollutant concentrations reach dangerous level near the source of emission. Hence, it is important that we understand the natural processes that are responsible for their dispersion. The degree of stability of the atmosphere in turn depends on the rate of change of ambient temperature with altitude.

## **LECTURE-33**

### **VERTICAL DISPERSION OF POLLUTANTS**

As a parcel of air in the atmosphere rises, it experiences decreasing pressure and thus expands. This expansion lowers the temperature of the air parcel, and therefore the air cools as it rises. The rate at which dry air cools as it rises is called the dry adiabatic lapse rate and is independent of the ambient air temperature. The term adiabatic means that there is no heat exchange between the rising parcel of air under consideration and the surrounding air. The dry adiabatic lapse rate can be calculated from the first law of thermodynamics (1°C per 100m). As the air parcel expands, it does work on the surroundings. Since the process is usually rapid, there is no heat transfer between the air parcel and the surrounding air.

*Saturated adiabatic lapse rate, ( $\Gamma_s$ )*



Unlike the dry adiabatic lapse rate, saturated adiabatic lapse rate is not a constant, since the amount of moisture that the air can hold before condensation begins is a function of temperature. A reasonable average value of the moist adiabatic lapse rate in the troposphere is about 6°C/Km.

### **Example**

An air craft flying at an altitude of 9 km draws in fresh air at - 40°C for cabin ventilation. If that fresh air is compressed to the pressure at sea level, would the air need to be heated or cooled if it is to be delivered to the cabin at 20°C.

### **Solution**

As the air is compressed, it warms up it is even easier for the air to hold whatever moisture it may have, had .so there is no condensation to worry about and the dry adiabatic lapse rate can be used, At 10°C per km, compression will raise the air temperature by

$10 \times 9 = 90^\circ\text{C}$  making it  $-40 + 90^\circ\text{C} = 50^\circ\text{C}$

It needs to be the air conditioned The air in motion is called wind, air which is rushing from an area of high pressure towards an area of low pressure. When the weather-man reports the wind to us he uses a measuring system worked out in 1805 by Adoniral Beaufort. For example, a “moderate breeze” is a wind of 13 to 18 miles an hour. Obviously air quality at a given site varies tremendously from day to day, even though the emissions remain relatively constant. The determining factors have to do the weather: how strong the winds are, what direction they are blowing , the temperature profile , how much sun light available to power photochemical reactions, and how long it has been since the last strong winds or precipitation were able to clear the air. Air quality is dependent on the dynamics of the atmosphere, the study of which is called *meteorology*

### Temperature lapse rate and stability

The ease with which pollutants can disperse vertically into the atmosphere is largely determined by the rate of change of air temperature with altitude. For some temperature profiles the air is stable, that is, air at a given altitude has physical forces acting on it that make it want to remain at that elevation. Stable air discourages the dispersion and dilution of pollutants. For other temperature profiles, the air is unstable. In this case rapid vertical mixing takes place that encourages pollutant dispersal and increase air quality. Obviously, vertical stability of the atmosphere is an important factor that helps determine the ability of the atmosphere to dilute emissions; hence, it is crucial to air quality. Let us investigate the relationship between atmospheric stability and temperature. It is useful to imagine a “parcel” of air being made up of a number of air molecules with an imaginary boundary around them. If this parcel of air moves upward in the atmosphere, it will experience less pressure, causing it to expand and cool. On the other hand, if it moves dawn ward, more pressure will compress the air and its temperature will increase. As a starting point, we need a relationship that expires an air parcel’s change of temperature as it moves up or down in the atmosphere. As it moves, we can imagine its

temperature, pressure and volume changing, and we might imagine its surrounding adding or subtracting energy from the parcel. If we make small changes in these quantities, and apply both the ideal gas law and the first law of thermodynamics, it is relatively straightforward to drive the following expression.

$$dQ = C_p dT - V dP \dots\dots\dots (2.1)$$

- Where:  $dQ$  = heat added to the parcel per unit mass (J/kg)
- $C_p$  = Specific heat at a constant pressure (1005J/Kg-°C)
- $dT$  = Incremental temperature change(°C)
- $V$  = volume per unit mass (m<sup>3</sup>/kg)
- $dP$  = Incremental pressure change in the parcel(Pa)

Let us make the quite accurate assumption that as the parcel moves, there is no heat transferred across its boundary, that is, that this process is *adiabatic*

This means that  $dQ = 0$ ; so we can rearrange (2.1) as

$$\frac{dT}{dP} = \frac{V}{C_p} \dots\dots\dots (2.2)$$

The above equation gives us an indication of how atmospheric temperature would change with air pressure, but what are really interested in is how it changes with altitude. To do that we need to know how pressure and altitude are related. Consider a static column of air with a cross section  $A$ , as shown in figure. A horizontal slice of air in that column of thickness  $dZ$  and density  $\rho$  will have mass  $\rho A dZ$ . If the pressure at the top of the slice due to the weight of air above it is  $P(Z+dZ)$ , then the pressure at the bottom of the slice,  $P(Z)$  will be  $P(z+dz)$  plus the added weight per unit area of the slice it self:

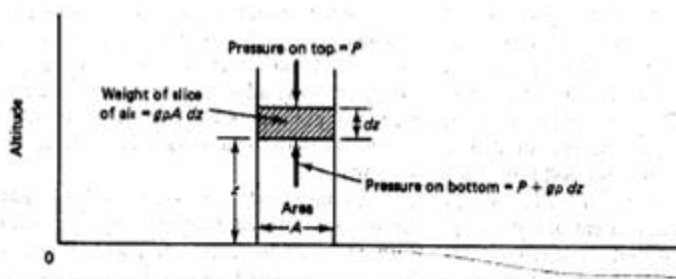

A column of air in static equilibrium used to determine the relationship between air pressure and altitude.

$$P(z) = P(z + dz) + \frac{\rho g A dz}{A} \text{-----} (2.3)$$

Where:  $g$  is the gravitational constant. We can write the incremental pressure  $dP$  for incremental change in elevation,  $dz$  as

$$dP = p(z+dz) - p(z) = -\rho g dz \text{.....} (2.4)$$

Expressing the rate of change in temperature with altitude as a product, and substituting in (2.2) and (2.3), gives

$$\frac{dT}{dZ} = \frac{dT}{dP} \times \frac{dP}{dZ} = \frac{V}{C_p} (-g\rho) \text{-----} (2.5)$$

However, since  $V$  is volume per unit mass and  $\rho$  is mass per unit volume, the product  $V\rho=1$ , and the expression simplifies to

$$\frac{dT}{dZ} = \frac{-g}{C_p} \text{-----} (2.6)$$

The negative sign indicates that temperature decreases with increasing altitude. Substituting the constant  $g = 9.806\text{m/s}^2$ , and the constant  $-$ volume specific heat of dry air at room temperature,  $C_p 1005\text{J/kg} \cdot \text{0C}$  in (2

.6) yields

$$\frac{dT}{dZ} = \frac{-9.806\text{m/s}^2}{1005\text{J/kg} \cdot \text{0C}} \times \frac{1\text{J}}{\text{Kg} \cdot \text{m}^2/\text{s}^2} = -0.00976^\circ\text{C/m} \text{.....} (2.7)$$

$$\Gamma = -\frac{dT}{dZ} = 9.76^\circ\text{C/km} \approx 10^\circ\text{C} \text{.....} (2.8)$$

## LECTURE-34

### ATMOSPHERIC STABILITY

The ability of the atmosphere to disperse the pollutants emitted in to it depends to a large extent on the degree of stability. A comparison of the adiabatic lapse rate with the environmental lapse rate gives an idea of stability of the atmosphere. When the environmental lapse rate and the dry adiabatic lapse rate are exactly the same, a raising parcel of air will have the same pressure and temperature and the density of the surroundings and would experience no buoyant force. Such atmosphere is said to be neutrally stable where a displaced mass of air neither tends to return to its original position nor tends to continue its displacement

When the environmental lapse rate  $(-dT/dz)_{Env}$  is greater than the dry adiabatic lapse rate,  $\Gamma$  the atmosphere is said to be super adiabatic. Hence a raising parcel of air, cooling at the adiabatic rate, will be warmer and less dense than the surrounding environment. As a result, it becomes more buoyant and tends to continue its up ward motion. Since vertical motion is enhanced by buoyancy, such an atmosphere is called unstable. In the unstable atmosphere the air from different altitudes mixes thoroughly. This is very desirable from the point of view of preventing pollution, since the effluents will be rapidly dispersed through out atmosphere. On the other hand, when the environmental lapse rate is less than the dry adiabatic lapse rate, a rising air parcel becomes cooler and denser than its surroundings and tends to fall back to its original position. Such an atmospheric condition is called stable and the lapse rate is said to be sub adiabatic. Under stable condition there is very little vertical mixing and pollutants can only disperse very slowly. As result, their levels can build up very rapidly in the environment. When the ambient lapse rate and the dry adiabatic lapse rate are exactly the same, the atmosphere has neutral stability. Super adiabatic condition prevails when the air temperature drops more than  $1^{\circ}\text{C}/100\text{m}$ ; sub adiabatic condition prevail when the air temperature drops at the rate less than  $1^{\circ}\text{C}/100\text{m}$

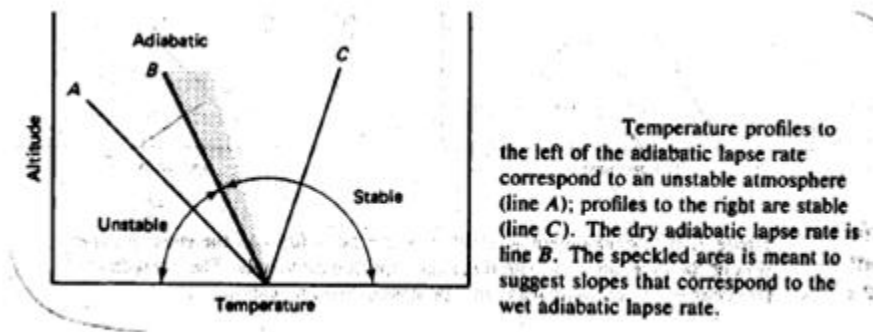

### Inversion

Atmospheric inversion influences the dispersion of pollutants by restricting vertical mixing. There are several ways by which inversion layers can be formed. One of the most common types is

the elevated **subsidence inversion**, This is usually associated with the sub tropical anti cyclone where the air is warmed by compression as it descends in a high pressure system and achieves temperature higher than that of the air under neath. If the temperature increase is sufficient, an inversion will result

- It lasts for months on end
- Occur at higher elevation
- More common in summer than winter

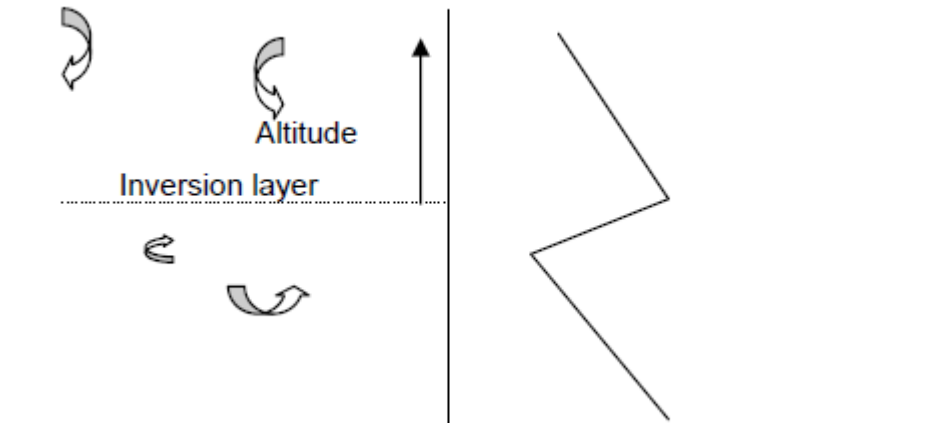

The subsidence is caused by air flowing down to replace air, which has flowed out of the high-pressure region

### Radiation Inversion

The surface of the earth cools down at night by radiating energy toward space. On cloudy night, the earth's radiation tends to be absorbed by water vapor, which in turn reradiates some of that energy back to the ground. On the clear night, however, the surface more readily radiate energy to space, and thus ground cooling occurs much more rapidly. As the ground cools, the temperature of the air in contact with the ground also drops. As is often the case on clear winter nights, the temperature of this air just above the ground becomes colder than the air above it, creating an inversion. Radiation inversions begins to form at dusk .As the evening progresses, the inversion extends to a higher and higher elevation, reaching perhaps a few hundred meters before the morning sun warms the ground again, breaking up the inversion.

Radiation inversion occurs close to the ground, mostly during the winter, and last for only a matter of hours. They often begin at about the time traffic builds up in the early evening, which traps auto exhaust at ground level and causes elevated concentration of pollution for commuters. With out sunlight, photochemical reactions can not takes place, so the biggest problem is usually accumulation of carbon monoxide (CO). In the morning, as the sun warms the ground and the inversion begins to the break up, pollutants that have been trapped in the stable air mass are suddenly brought back to earth in a process known as fumigation. Fumigation can cause short lived high concentrations of pollution at ground level.

Radiation inversions are important in another context besides air pollution. Fruit growers in places like California have long known that their crops are in greatest danger of frost damage on winter nights when the skies are clear and a radiation inversion sets in. Since the air even a few meters up is warmer than the air at crop level, one way to help protect sensitive crops on such nights is simply to mix the air with large motor driven fans.

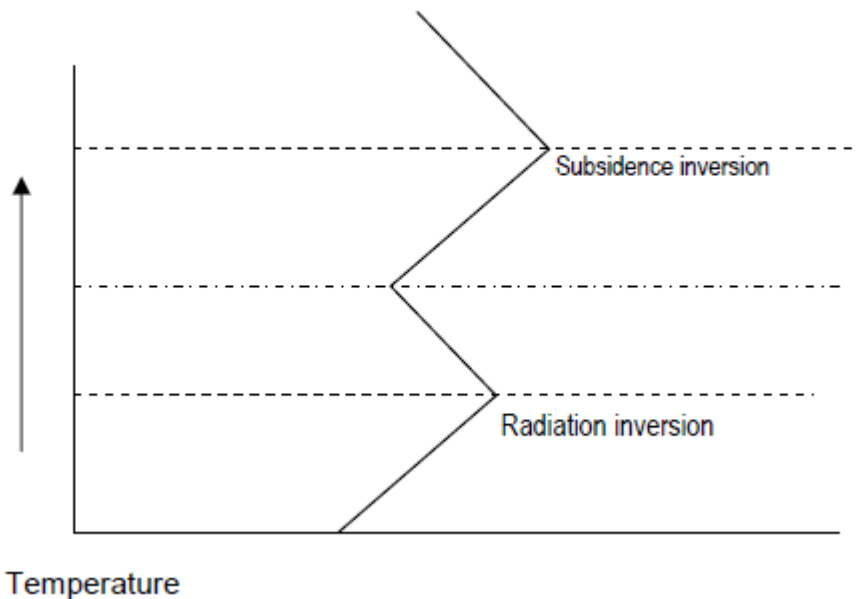

The third type of inversion, known as advective inversion is formed when warm air moves over a cold surface or cold air. The inversion can be ground based in the former case, or elevated in the latter case. An example of an elevated advective inversion occurs when a hill range forces a warm land breeze to follow at high levels and cool sea breezes flow at low level in the opposite direction.

### TOPOGRAPHICAL EFFECTS

In large bodies of water the thermal inertia of the water causes a slower temperature change than the nearby land. For example, along an ocean coastline and during periods of high solar input, the daytime air temperature over the ocean is lower than over the land. The relatively warm air over the land rises and is replaced by cooler ocean air. The system is usually limited to altitudes of several hundred meters, which of course, is where pollutants are emitted. The breeze develops during the day and is strongest in mid-afternoon. At night the opposite may occur, although, usually not with such large velocities. At night the ocean is relatively warm and the breeze is from the cooler land to the warmer ocean. The on-shore breeze is most likely in the summer months, while the off-shore land breeze more likely occurs in winter months. A second common wind system caused by topographical effect is the mountain-valley wind. In this case the air tends to flow down the valley at night. Valleys are cooler at higher elevation and the driving force for the airflow results from the differential cooling. Similarly, cool air drains off the mountain at night and flows in to the valley. During the daylight hours an opposite flow may

occur as the heated air adjacent to the sun warmed ground begins to rise and flow both up the valley and up the mountain slopes. However, thermal turbulence may mask the daytime up-slope flow so that it is not as strong as the nighttime down - slope flow. Both the sea breeze and the mountain valley wind are important in meteorology of air pollution. Large power stations are often located on ocean costs or adjacent to large lakes. In this case the stack effluent will tend to drift over the land during the day and may be subjected to fumigation.

Wind velocity and turbulence

The wind velocity profile is influenced by the surface roughness and time of the day. During the day, solar heating causes thermal turbulence or eddies set up convective currents so that turbulent mixing is increased. This results in a more flat velocity profile in the day than that at night. The second type of turbulence is the mechanical turbulence, which is produced by shearing stress generated by air movement over the earth's surface. The greater the surface roughness, the greater the turbulence. The mean wind speed variation with altitude in the planetary boundary layer can be represented by a simple empirical power.

$$\frac{U}{U_1} = \left[ \frac{Z}{Z_1} \right]^\alpha \text{-----(2.11)}$$

Where: U is the wind at altitude Z

U<sub>1</sub> is the wind speed at altitude Z<sub>1</sub>

α The exponent varies between 0.14 and 0.5 depending on the roughness of the ground surface as well as on the temperature stability of the atm.

α = 0.25 for unstable atmosphere

= 0.5 for stable condition

In practice, because of the appreciable change in wind speed with altitude, a wind speed value must be quoted with respect to the elevation at which it is measured. This reference height for surface wind measurement is usually 10 meters

Surface configuration	Stability	α
Smooth open country	Unstable	0.11
	Neutral	0.14
	Moderate stability	0.20
	Large stability	0.33
Flat open country		0.16
Sub-urns		0.28
Urban area		0.40

Atmospheric turbulence is characterized by different sizes of eddies. These eddies are primarily responsible for diluting and transporting the pollutants injected in to the atmosphere. If the size of the eddies is larger than the size of the plume or a puff then the plume or the puff will be transported down wind by the eddy with little dilution. Molecular diffusion will ultimately dissipate the plume or the puff. If the eddy is smaller than the plume or the puff, the plume or the puff will be disperse uniformly as the eddy entrains fresh air at its boundary.

## **LECTURE-35**

### **Plume behavior**

The behavior of a plume emitted from an elevated source such as a tall stack depends on the degree of instability of the atmosphere and the prevailing wind turbulence.

#### **Classification of plume behavior**

1. **Looping:** it occurs under super adiabatic conditions with light to moderate wind speeds on a hot summer after noon when large scale thermal eddies are present. The eddies carry portion of a plume to the ground level for short time periods, causing momentary high surface concentration of pollutants near the stack. Thus the plume moves about vertically in a spastic fashion and the exhaust gases disperse rapidly
2. **Coning:** It occurs under cloudy skies both during day and night, when the lapse rate is essentially neutral. The plume shape is vertically symmetrical about the plume line and the major part of the pollutant concentration is carried down -wind fairly far before reaching the ground level.
3. **Fanning:** occurs when the plume is dispersed in the presence of very light winds as a result of strong atmospheric inversions. The stable lapse rate suppresses the vertical mixing, but not the horizontal mixing entirely. For high stacks, fanning is considered a favourable meteorological condition because the plume does not contribute to ground pollution.
4. **Fumigation:** here a stable layer of air lies a short distance above the release point of the plume and the unstable air layer lies below the plume .This unstable layer of air causes the pollutant to mix down -wind toward the ground in large lumps, but fortunately this condition is usually of short duration lasting for about 30 minutes Fumigation is favored by clear skies and light winds, and it is more common in the summer seasons.
5. **Lofting :** The condition for lofting plume are the inverse of those for fumigation , when the pollutants are emitted above the inverse layer , they are dispersed vigorously on the up ward direction since the top of the inversion layer acts as a barrier to the movement of the pollutants towards the ground .



6. **Trapping:** occurs when the plume effluent is caught between two inversion layers. The diffusion of the effluent is severely restricted to the unstable layer between the two unstable layers.

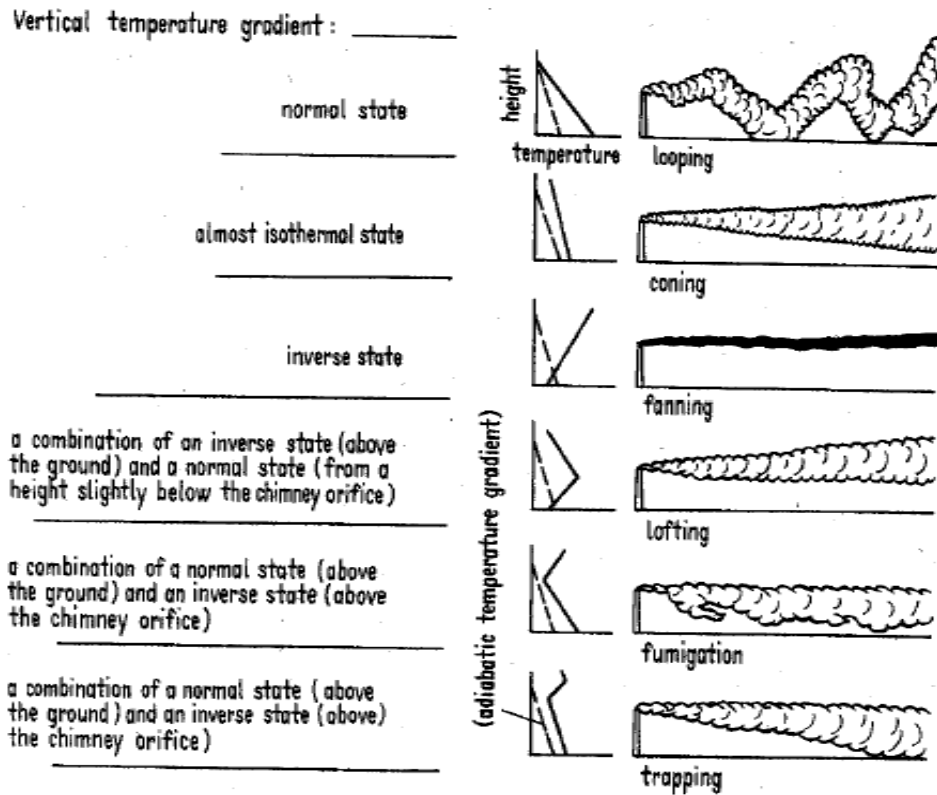

## PLUME DISPERSION

Dispersion is the process by which contaminants move through the air and a plume spreads over a large area, thus reducing the concentration of pollutants it contains. The plume spreads both horizontally and vertically. If it is gaseous, the motion of the molecules follows the law of gaseous diffusion. The most commonly used model for the dispersion of gaseous air pollutants is the Gaussian, developed by Pasquill, in which gases dispersed in the atmosphere are assumed to exhibit ideal gas behavior.

### The Gaussian plume model

The present tendency is to interpret dispersion data in terms of the Gaussian model. The standard deviations are related to the eddy diffusivities.

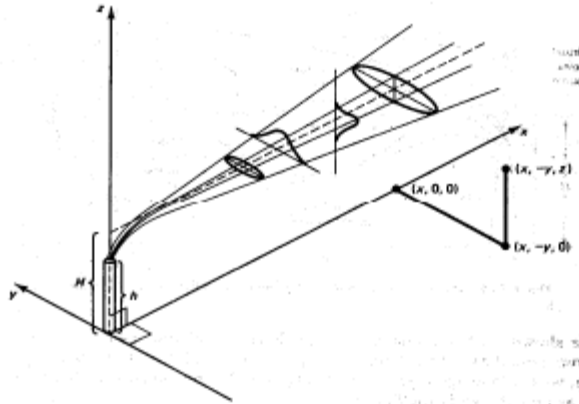

Plume dispersion coordinate system, showing Gaussian distributions in the horizontal and vertical directions (Turner, 1970)

Fig. Dispersion situation

(a) Ground level concentration

In this case  $Z=0$

$$[\rho A](x, y, 0, H) = \frac{Q}{\pi \delta y \delta z u} \exp\left(-\frac{1}{2}\left(\frac{y}{\delta y}\right)^2\right) \exp\left[-\frac{1}{2}\left(\frac{H}{\delta z}\right)^2\right] \text{--- (413)}$$

(b) Ground level center line concentration

In this case  $Z=0$  and  $y=0$

(c) When the emission source is at the ground level i.e.  $H=0$

$$\boxed{\phantom{\frac{Q}{\pi \delta y \delta z u}}} \frac{Q}{\pi \delta y \delta z u} \text{--- (2.15)}$$

||

**Estimation of  $\delta y$  and  $\delta z$**

The values of  $\delta y$  and  $\delta z$  have been shown to be related to the diffusion coefficient in the y and z directions. As might be expected,  $\delta y$  and  $\delta z$  are functions of down wind distance x from the source as well as the atmospheric stability conditions. Based on the experimental observation of the dispersion of plumes, Pasquill and Gifford have devised a method for calculating  $\delta y$  and  $\delta z$  of the spreading plume from knowledge of the atmospheric stability. Six categories of the atmospheric stability; A through F, were suggested and these are shown in the table 2.1 as a function of wind and solar radiation

$$\delta y = Ax^{0.903} \text{-----} \quad (2.16)$$

$$\delta z = Bx^P \text{-----} \quad (2.17)$$

Where: A, B, and P are constants

**stability categories**

Wind speed (m/sec) at z=10m	Day (incoming S. R.)			Night (thin over cast)	
	<i>Strong</i>	<i>Moderate</i>	<i>Slight</i>	$\geq 4/8$ cloud	$\leq 3/8$ cloud
<2	A	A-B	B	E	F
2-3	A-B	B	C	E	F
3-5	B	B-C	C	D	E
5-6	C	C-D	D	D	D
>6	C	D	D	D	D

A: extremely unstable

D: Neutral condition

B: Moderately unstable

E: Slightly stable

C: Slightly unstable

F: Moderately stable

**fitted value for  $\delta y$  and  $\delta z$**

Class	A	X1(meters)	X $\leq$ X1		X2(meters)	x1 $\leq$ x $\leq$ x2	
			B	P		B	P
A	0.4	250	0.125	1.03	500	0.00883	1.5
B	0.295	1000	0.119	0.986	1000	0.0579	1.09
C	0.2	1000	0.111	0.911	1000	0.111	0.911
D	0.13	1000	0.105	0.827	1000	0.392	0.636
E	0.098	1000	0.100	0.778	1000	0.373	0.587

### Example 1

A coal burning electric generating plant emits 1.1 kg/ min. of SO<sub>2</sub> from a stack with an effective height of 60m. On a thinly over cast evening with a wind speed of 5 m/ sec. what is the ground level concentration of SO<sub>2</sub>, 500m directly down wind from the stack .

$$\begin{aligned}\delta y &= Ax^{0.903} & \delta z &= BX^P \\ &= (0.13) \times 500^{0.90} & &= (0.105). (500)^{0.827} \\ &= 35\text{m} & &= 18\text{m}\end{aligned}$$

$$\begin{aligned}[\rho A](0.5,0,60) &= \frac{Q}{\pi \delta y \delta z u} \cdot \exp\left[\frac{-1}{2}\left(\frac{H}{\delta z}\right)^2\right] \\ &= \frac{18\text{g/sec}}{\pi \times 3.5 \times 18 \times 5} \cdot \exp\left[\frac{-1}{2}\left(\frac{60}{18}\right)^2\right] \\ &= 7.4\mu\text{g}\end{aligned}$$

### Example 2

A chimney with a design stack height of 250 m s emitting SO<sub>2</sub> at a rate of 500g/sec on a sunny day in June with moderate wind speed at a stack altitude, the volumetric flow rate found to be 265m<sup>3</sup>/sec. , with a wind speed of 6 m/sec: at 10 m level .Estimate the concentration of SO<sub>2</sub> down wind for the following situations

- (a) (ρ so<sub>2</sub>) (1000,0,0,250)
- (b) (ρ so<sub>2</sub>) (1000,50,0,250)
- (c) (ρ so<sub>2</sub>) (1000,50,20,250)

### Solution

On a sunny day in June the incoming solar radiation will be strong. Also, the air will be unstable. A moderate wind speed

at the stack altitude will be around 5-7 m/sec. Let us take  $u' = 6$  m/s. From equation 2.11 the velocity  $u_1'$  at 10 m level can be obtained:

$$u_1 = u (z_1/H)^\alpha \quad \alpha = 0.25 \quad \text{unstable condition}$$

$$6(110/250)^{0.25}$$

$$= 2.7 \text{ m/sec.}$$

This shows that the surface wind speed is between 2 and 3 m/sec Reference to table 2.1 shows a stability class of A-B we choose B as a conservative answer. The values of  $\delta y$  and  $\delta z$  can be calculated from the information given in table 2 at a distance of 1000m

$$\delta y = A \cdot x^{0.903} \qquad \delta z = Bx^P$$

$$= 0.295(1000)^{0.903} \qquad = 0.119(1000)^{0.986}$$

$$= 151\text{m} \qquad = 108\text{m}$$

$$(a) [\rho \delta o_2](1000,0,0,250) = \frac{500 \times 10^6}{\pi(151)(108)6} \exp\left[\frac{-1}{2}\left(\frac{250}{108}\right)^2\right]$$

$$= 112 \mu\text{g}/\text{m}^3$$

$$(b) [\rho \delta o_2](1000,50,0,250) = \frac{Q}{\pi \delta y \delta z u'} \cdot \exp\left[\frac{-1}{2}\left(\frac{y}{\delta y}\right)^2\right] \exp\left[\frac{-1}{2}\left(\frac{H}{\delta z}\right)^2\right]$$

$$= \frac{500 \times 10^6}{\pi \cdot 151(108)6} \cdot \exp\left[\frac{-1}{2}\left(\frac{50}{151}\right)^2\right] \cdot \exp\left[\frac{-1}{2}\left(\frac{250}{108}\right)^2\right]$$

$$= 106 \mu\text{g}/\text{m}^3$$

$$(c) [\rho \delta o_2](1000,50,20,250) = \frac{Q}{2\pi \delta y \delta z u'} \cdot \exp\left[\frac{-1}{2}\left(\frac{y}{\delta y}\right)^2\right] \left\{ \exp\left[\frac{-1}{2}\left(\frac{z-H}{\delta z}\right)^2\right] + \exp\left[\frac{-1}{2}\left(\frac{z+H}{\delta z}\right)^2\right] \right\}$$

$$= 113 \mu\text{g}/\text{m}^3$$

## LECTURE-36

### Plume rise

Generally, effluent plumes from the chimney stacks are released into the atmosphere at elevated temperatures. The rise of the plume after release to the atmosphere is caused by buoyancy and the vertical momentum of the effluent. Under windless conditions, the plume rises vertically but more often it is bent as a result of the wind that is usually present. This rise of the plume adds to the stack an additional height  $\Delta H$ , such that the height  $H$  of the virtual origin is obtained by adding the term  $\Delta H$ , the plume rise, to the actual height of the stack,  $H_s$ . The plume center line height  $H = H_s + \Delta H$  is known as the effective stack height and it is this height that is used in the Gaussian plume calculations.

### Plume rise

#### Estimation of plume rise

##### **1. Buoyant plumes**

In the case of buoyant plumes, the influence of buoyancy is much greater than the influence of vertical momentum. Such plumes are usually obtained when the release temperatures are more than 50°C greater than ambient atmospheric temperatures.

Holland's equation

$$\Delta H = \frac{V_s \cdot D_s}{U} \left( 1.5 + 2.68 \times 10^{-3} \text{ pa} \cdot \frac{T_s - T_a}{T_s} \cdot D_s \right) \text{----- (2.18)}$$

Where:  $V_s$  = stack gas exit velocity, m/s

$P_a$  = atmospheric pressure, mb

$T_s$  = stack gas temperature, K

$T_a$  = ambient air temperature

$U$  = wind speed, m/sec.

$D_s$  = Diameter of stack outlet, m

##### **2. Plume rise under stable and calm conditions**

When there is little or no wind, the bending of the plume is negligible small and it rises to some height where the buoyancy force is completely dissipated. The recommended equation for such a situation is

$$\Delta H = 5F^{1/4} \cdot S^{-3/8} \text{----- (2.19)}$$

$$F = g v s \left( \frac{D_s}{2} \right)^2 \cdot \frac{T_s - T_a}{T_s} \cdot \frac{m^4}{s^2} \text{-----(2.20)}$$

$$S = \frac{g}{T_a} \left[ \left( \frac{dT}{dZ} \right)_{env.+\Gamma} \right] \times \frac{1}{\alpha^2} \text{-----(2.21)}$$

Where: F--is the buoyancy flux parameter

S--is the stability parameter

α-- Degree of stability

For large volume of flow rates greater than 50m<sup>3</sup>/s

$$\Delta H = 150 \frac{F}{(U^-)^3} \text{-----(2.22)}$$

### 3. Non- buoyant plumes

For sources at temperature close to the ambient or less than 50 ° C above ambient and having exit speed of at least 10m/sec, the following equation can be used

$$\Delta H = D_s \left( \frac{V_s}{U^-} \right)^{1.4} \text{-----(2.23)}$$

## LECTURE-37

### AIR POLLUTION CONTROL

Pollution control equipment can reduce emissions by cleaning exhaust and dirty air before it leaves the business. A wide variety of equipment can be used to clean dirty air. DNR engineers carefully study and review how these controls may work and the methods and requirements are put into a permit - a major duty performed by the DNR.

#### **Process Controls**

There are other ways to reduce emissions besides using pollution control equipment--prevent emissions to begin with. Air quality permits help minimize, reduce or prevent emissions as much as possible by placing requirements on how things are done.

Permits can specify the quantity, type, or quality of fuel or other substance used in a process. For example, a permit might specify the maximum percent of sulfur that can exist in the coal to

reduce sulfur dioxide emissions. A permit may specify the quantity of volatile chemicals in paint, solvent, adhesive or other product used in large quantity during manufacturing. Permits can also help reduce the impact of emitted pollutants on local air by specifying smokestack height and other factors.

Engineers can also set combustion specifications to minimize emissions. For example, to help reduce nitrogen oxide formation, the combustion conditions in the furnace can be altered. The flame temperature can be lowered or raised, the amount of time air remains in the combustion chamber can be altered, or the mixing rate of fuel and air can be changed. These options are often reviewed, studied and best choices made depending upon cost, plant design and many other variables.

### GRAVITY SETTLING CHAMBERS

This is a simple particulate collection device using the principle of gravity to settle the particulate matter in a gas stream passing through its long chamber. The primary requirement of such a device would be a chamber in which the carrier gas velocity is reduced so as to allow the particulate matter to settle out of the moving gas stream under the action of gravity. This particulate matter is then collected at the bottom of the chamber. The chamber is cleaned manually to dispose the waste.

The gas velocities in the settling chamber must be sufficiently low for the particles to settle due to gravitational force. Literature indicates that gas velocity less than about 3 m/s is needed to prevent re-entrainment of the settled particles. The gas velocity of less than 0.5 m/s will produce good results.

Curtains, rods, baffles and wire mesh screens may be suspended in the chamber to minimize turbulence and to ensure uniform flow. The pressure drop through the chamber is usually low and is due to the entrance and exit losses.

The velocity of the particles in the settling chamber can be obtained by Stokes' law as follows:

$$V_s = (g(r_p - r) D^2) / 18 \mu$$

Where,

- D = Diameter of the particle.
- g = acceleration due to gravity
- $r_p$  = density of the particle
- r = density of the gas
- $\mu$  = viscosity of the gas



The advantages of settling chambers are:

- i) low initial cost,
- ii) simple construction,
- iii) low maintenance cost,
- iv) low pressure drop,
- v) dry and continuous disposal of solid particles,
- vi) use of any material for construction, and
- vii) temperature and pressure limitations will only depend on the nature of the construction material.

The disadvantages of this device are

- i) large space requirements and
- ii) only comparatively large particles (greater than 10 micron) can be collected.

Because of the above advantages and disadvantages, settling chambers are mostly used as pre-cleaners. They are sometimes used in the process industries, particularly in the food and metallurgical industries as the first step in dust control. Use of settling chambers as pre-cleaners can also reduce the maintenance cost of high efficiency control equipment, which is more subject to abrasive deterioration.

#### CYCLONES:

Settling chambers discussed above are not effective in removing small particles. Therefore, one needs a device that can exert more force than gravity force on the particles so that they can be removed from the gas stream. Cyclones use centrifugal forces for removing the fine particles. They are also known as centrifugal or inertial separators.

The cyclone consists of a vertically placed cylinder which has an inverted cone attached to its base. The particulate laden gas stream enters tangentially at the inlet point to the cylinder. The velocity of this inlet gas stream is then transformed into a confined vortex, from which centrifugal forces tend to drive the suspended particles to the walls of the cyclone. The vortex turns upward after reaching at the bottom of the cylinder in a narrower inner spiral. The clean gas is removed from a central cylindrical opening at the top, while the dust particles are collected at the bottom in a storage hopper by gravity.

The efficiency of a cyclone chiefly depends upon the cyclone diameter. For a given pressure drop, smaller the diameter, greater is the efficiency, because centrifugal action increases with decreasing radius of rotation. Centrifugal forces employed in modern designs vary from 5 to 2500 times gravity depending on the diameter of the cyclone. Cyclone efficiencies are greater than 90% for the particles with the diameter of the order of 10  $\mu$ . For particles with diameter higher than 20  $\mu$ , efficiency is about 95%.

The efficiency of a cyclone can be increased by the use of cyclones either in parallel or in series. A brief explanation of both arrangements is given below:

Multiple Cyclones:

A battery of smaller cyclones, operating in parallel, designed for a constant pressure drop in each chamber. The arrangement is compact, with convenient inlet and outlet arrangements. They can treat a large gas flow, capturing smaller particles.

Cyclones in series:

Two cyclones are used in series. The second cyclone removes the particles that were not collected in the first cyclone, because of the statistical distribution across the inlet, or accidental re-entrainment due to eddy currents and re-entrainment in the vortex core, thus increasing the efficiency.

The advantages of cyclones are:

- i) low initial cost,
- ii) simple in construction and operation,
- iii) low pressure drop,
- iv) low maintenance requirements,
- v) continuous disposal of solid particulate matter, and
- vi) use of any material in their construction that can withstand the temperature and pressure requirements.

The disadvantages of cyclones include:

- i) low collection efficiency for particles below 5 – 10  $\mu$  in diameter,
- ii) severe abrasion problems can occur during the striking of particles on the walls of the cyclone, and
- iii) a decrease in efficiency at low particulate concentration.

Typical applications of cyclones are:

- i) For the control of gas borne particulate matter in industrial operations such as cement manufacture, food and beverage, mineral processing and textile industries.
- ii) To separate dust in the disintegration operations, such as rock crushing, ore handling and sand conditioning in industries.
- iii) To recover catalyst dusts in the petroleum industry.
- iv) To reduce the fly ash emissions.

The operating problems are:

- i) Erosion: Heavy, hard, sharp edged particles, in a high concentration, moving at a high velocity in the cyclone, continuously scrape against the wall and can erode the metallic surface.
- ii) Corrosion: If the cyclone is operating below the condensation point, and if reactive gases are present in the gas stream, then corrosion problems can occur. Thus the product should be kept

above the dew point or a stainless steel alloy should be used.  
iii) Build – up: A dust cake builds up on the cyclone walls, especially around the vortex finder, at the ends of any internal vanes, and especially if the dust is hygroscopic. It can be a severe problem.

## **LECTURE-38**

### **ELECTROSTATIC PRECIPITATORS:**

Electrostatic precipitators (ESP) are particulate collection devices that use electrostatic force to remove the particles less than 5 micron in diameter. It is difficult to use gravity settlers and cyclones effectively for the said range of particles. Particles as small as one-tenth of a micrometer can be removed with almost 100% efficiency using electrostatic precipitators.

The principle behind all electrostatic precipitators is to give electrostatic charge to particles in a given gas stream and then pass the particles through an electrostatic field that drives them to a collecting electrode.

The electrostatic precipitators require maintenance of a high potential difference between the two electrodes, one is a discharging electrode and the other is a collecting electrode. Because of the high potential difference between the two electrodes, a powerful ionizing field is formed. Very high potentials – as high as 100 kV are used. The usual range is 40- 60 kV. The ionization creates an active glow zone (blue electric discharge) called the 'corona' or 'corona glow'. Gas ionization is the dissociation of gas molecules into free ions.

As the particulate in the gas pass through the field, they get charged and migrate to the oppositely charged collecting electrode, lose their charge and are removed mechanically by rapping, vibration, or washing to a hopper below.

In summary, the step by step process of removing particles using ESPs is:

- i) Ionizing the gas.
- ii) Charging the gas particles.
- iii) Transporting the particles to the collecting surface.
- iv) Neutralizing, or removing the charge from the dust particles.
- v) Removing the dust from the collecting surface.

The major components of electrostatic precipitators are:

- i) A source of high voltage
- ii) Discharge and collecting electrodes.
- iii) Inlet and outlet for the gas.
- iv) A hopper for the disposal of the collected material.
- v) An outer casing to form an enclosure around the electrodes.

The ESP is made of a rectangular or cylindrical casing. All casings provide an inlet and outlet connection for the gases, hoppers to collect the precipitated particulate and the necessary discharge electrodes and collecting surfaces. There is a weatherproof, gas tight enclosure over the precipitator that houses the high voltage insulators.

Electrostatic precipitators also usually have a number of auxiliary components, which include access doors, dampers, safety devices and gas distribution systems. The doors can be closed and bolted under normal conditions and can be opened when necessary for inspection and maintenance. Dampers are provided to control the quantity of gas. It may either be a guillotine, a louver or some such other device that opens and closes to adjust gas flow.

The safety grounding system is extremely important and must always be in place during operation and especially during inspection. This commonly consists of a conductor, one end of which is grounded to the casing, and the other end is attached to the high voltage system by an insulated operating lever.

The precipitator hopper is an integral part of the precipitator shell and is made of the same material as the shell. Since ESPs require a very high voltage direct current source of energy for operation, transformers are required to step up normal service voltages to high voltages. Rectifiers convert the alternating current to unidirectional current.

Types of electrostatic precipitators:

There are many types of ESPs in use throughout the world. A brief description of three different types is given below:

**A) Single stage or two stage:**

In a single stage ESP, gas ionization and particulate collection are combined in a single step. An example is the “Cottrell” single-stage precipitator. Because it operates at ionizing voltages from 40,000 to 70,000 volts, DC, it may also be called a high voltage precipitator. It is used extensively for heavy duty applications such as utility boilers, large industrial boilers and cement kilns.

In the two-stage precipitator particles are ionized in the first chamber and collected in the second chamber. For example, “Penny”– the two stage precipitator uses DC voltages from 11,000 to 14,000 volts for ionization and is referred to as a low voltage precipitator. Its use is limited to low inlet concentration, normally not exceeding 0.025 grains per cubic feet. It is the most practical collection technique for many hydrocarbon applications, where the initial clear exhaust stack turns into a visible emission as vapor condenses.

**B) Pipe type or Plate type:**

In the pipe type electrostatic precipitators, a nest of parallel pipes form the collecting electrodes, which may be round, or square. Generally the pipe is about 30 cm in diameter or less. Most commonly a wire with a small radius of curvature, suspended along the axis of each pipe, is

used. The wires must be weighted or supported to retain proper physical tension and location, electrically insulated from the support grid and strong enough to withstand rapping or vibration for cleaning purpose. The gas flow is axial from bottom to top.

The pipe electrodes, may be 2-5 m high. Spacing between the discharge electrode and collecting electrode ranges from 8-20 cm. Precipitation of the aerosol particles occurs on the inner pipe walls, from which the material can be periodically removed by rapping of pipes or by flushing water. The pipe type precipitator is generally used for the removal of liquid particles.

In the plate type precipitators the collection electrodes consist of parallel plates. The discharge electrodes are again wires with a small curvature. Sometimes square or twisted rods can be used. The wires are suspended midway between the parallel plates and usually hang free with a weight suspended at the bottom to keep them straight. Discharge electrodes are made from non-corrosive materials like tungsten, and alloys of steel and copper. The gas flow is parallel to the plates.

The plates may be 1-2 m wide and 3-6 m high. The parallel plates should be at equally spaced intervals (between 15 and 35 cm). The collection of the aerosols takes place on the inner side of the parallel plates. The dust material can be removed by rapping either continuously or periodically. The dust particles removed fall into the hopper at the base of the precipitator.

Collection electrodes should have a minimum amount of collection surface, bulking resistance, resistance to corrosion and a consistent economic design.

Plate type precipitators are horizontal or vertical, depending on the direction of the gas flow. Gas velocities are maintained at 0.5-0.6 m/s in these precipitators. They're used for collection of solid particulate.

### **C) Dry and Wet Precipitators:**

If particulate matter is removed from the collecting electrodes, by rapping only, it is known as a dry precipitator. If, on the other hand, water or any other fluid is used for removal of the solid particulate matter, then it is known as a wet precipitator. In general, wet precipitators are more efficient. However, it is the dry type plate precipitators that are predominantly used.

#### **Efficiency:**

Generally, the collection efficiency of the electrostatic precipitator is very high, approaching 100%. Many installations operate at 98 and 99% efficiency. Some materials ionize more readily than others and are thus more adapted to removal by electrostatic precipitation.

Acid mists and catalyst recovery units have efficiencies in excess of 99%. However, for materials like carbon black, which have very low efficiencies due to very low collection capacity, by proper combination of an ESP with a cyclone, very high efficiencies can be achieved. The gas entering the ESP may be pre-treated (i.e., removing a portion of particulate) by using

certain mechanical collectors or by adding certain chemicals to the gas to change the chemical properties of the gas to increase their capacity to collect on the discharge electrode and thus increase the efficiency.

The factors affecting the efficiency of electrostatic precipitators are particle resistivity and particle re-entrainment. Both are explained below:

#### **A) Particle Resistivity :**

Dust resistivity is a measure of the resistance of the dust layer to the passage of a current. For practical operation, the resistivity should be  $10^7$  and  $10^{11}$  ohm-cm. At higher resistivities, particles are too difficult to charge. Higher resistivity leads to a decrease in removal efficiency. At times, particles of high resistivity may be conditioned with moisture to bring them into an acceptable range.

If the resistivity of the particles is too low, ( $<10$  ohm-cm), little can be done to improve efficiency. This is due to the fact that the particles accept a charge easily, but they dissipate it so quickly at the collector electrode, that the particles are re-entrained in the gas stream. This results in low efficiency.

Particle resistivity depends upon the composition of the dust and the continuity of the dust layer. Resistivity is also affected by the ESP operating temperature and by the voltage gradient that exists across the dust layer.

#### **B) Particle re-entrainment:**

This is a problem associated with particle charging. It occurs primarily in two situations – due to either inadequate precipitator area, or inadequate dust removal from the hopper. Re-entrainment reduces the precipitator performance, because of the necessity of recollecting the dust that had been previously removed from the carrier gas. The problem can be overcome by a proper design of the ESP and necessary maintenance.

The advantages of using the ESP are:

- i) High collection efficiency.
- ii) Particles as small as 0.1 micron can be removed.
- iii) Low maintenance and operating cost.
- iv) Low pressure drop (0.25-1.25 cm of water).
- v) Satisfactory handling of a large volume of high temperature gas.
- vi) Treatment time is negligible (0.1-10s).
- vii) Cleaning is easy by removing the units of precipitator from operation.
- viii) There is no limit to solid, liquid or corrosive chemical usage.

The disadvantages of using the ESP are:

- i) High initial cost.
- ii) Space requirement is more because of the large size of the equipment.
- iii) Possible explosion hazards during collection of combustible gases or particulate.
- iv) Precautions are necessary to maintain safety during operation. Proper gas flow distribution, particulate conductivity and corona spark over rate must be carefully maintained.
- v) The negatively charged electrodes during gas ionization produce the ozone.

The important applications of ESPs in different industries throughout the world are given as below:

i) Cement factories:

- a) Cleaning the flue gas from the cement kiln.
- b) Recovery of cement dust from kilns.

ii) Pulp and paper mills:

- a) Soda-fume recovery in the Kraft pulp mills.

iii) Steel Plants:

- a) Cleaning blast furnace gas to use it as a fuel.
- b) Removing tars from coke oven gases.
- c) Cleaning open hearth and electric furnace gases.

iv) Non-ferrous metals industry:

- a) Recovering valuable material from the flue gases.
- b) Collecting acid mist.

v) Chemical Industry:

- a) Collection of sulfuric and phosphoric acid mist.
- b) Cleaning various types of gas, such as hydrogen, CO<sub>2</sub>, and SO<sub>2</sub>.
- c) Removing the dust from elemental phosphorous in the vapor state.

vi) Petroleum Industry:

- a) Recovery of catalytic dust.

vii) Carbon Black industry:

- a) Agglomeration and collection of carbon black.

viii) Electric Power Industry:

- a) Collecting fly ash from coal-fired boilers.

### SCRUBBERS:

Scrubbers are devices that remove particulate matter by contacting the dirty gas stream with liquid drops. Generally water is used as the scrubbing fluid. In a wet collector, the dust is agglomerated with water and then separated from the gas together with the water.

The mechanism of particulate collection and removal by a scrubber can be described as a four-step process.

- i) **Transport** : The particle must be transported to the vicinity of the water droplets which are usually 10 to 1000 times larger.
- ii) **Collision** : The particle must collide with the droplet.
- iii) **Adhesion** : This is promoted by the surface tension property.
- iv) **Precipitation**: This involves the removal of the droplets, containing the dust particles from the gas phase.

The physical principles involved in the operation of the scrubbers are: i) impingement, ii) interception, iii) diffusion and iv) condensation. A brief description is given below:

**i) Impingement :**

When gas containing dust is swept through an area containing liquid droplets, dust particles will impinge upon the droplets and if they adhere, they will be collected by them. If the liquid droplet is approximately 100 to 300 times bigger than the dust particle, the collection efficiency of the particles is more, because the numbers of elastic collisions increase.

**ii) Interception:**

Particles that move with the gas stream may not impinge on the droplets, but can be captured because they brush against the droplet and adhere there. This is known as interception.

**iii) Diffusion:**

Diffusion of the particulate matter on the liquid medium helps in the removal of the particulate matter.

**iv) Condensation:**

Condensation of the liquid medium on the particulate matter increases the size and weight of the particles. This helps in easy removal of the particles.

The various types of scrubbers are:

- i) Spray towers.
- ii) Venturi scrubbers.
- iii) Cyclone scrubbers.
- iv) Packed scrubbers.
- v) Mechanical scrubbers.

The simpler types of scrubbers with low energy inputs are effective in collecting particles above 5 – 10  $\mu$  in diameter, while the more efficient, high energy input scrubbers will perform efficiently for collection of particles as small as 1 – 2  $\mu$  in diameter.

The advantages of scrubbers are:



- i) Low initial cost.
- ii) Moderately high collection efficiency for small particles.
- iii) Applicable for high temperature installations.
- iv) They can simultaneously remove particles and gases.
- v) There is no particle re- entrainment.

The disadvantages of scrubbers are:

- i) High power consumption for higher efficiency.
- ii) Moderate to high maintenance costs owing to corrosion and abrasion.
- iii) Wet disposal of the collected material.

The scrubbers are used in a variety of applications. Some of the situations are:

- i) They're particularly useful in the case of a hot gas that must be cooled for some reason.
- ii) If the particulate matter is combustible or if any flammable gas is present, even in trace amounts, in the bulk gas phase, a scrubber is preferred to an electrostatic precipitator.
- iii) Scrubbers can be used when there are waste water treatment systems available on the site, with adequate reserve capacity to handle the liquid effluent.
- iv) Scrubbers are also used when gas reaction and absorption are required simultaneously with particulate control.

## LECTURE-39

### FABRIC FILTERS:

Fabric filtration is one of the most common techniques to collect particulate matter from industrial waste gases. The use of fabric filters is based on the principle of filtration, which is a reliable, efficient and economic methods to remove particulate matter from the gases. The air pollution control equipment using fabric filters are known as bag houses.

### **Bag Houses**

A bag house or a bag filter consists of numerous vertically hanging, tubular bags, 4 to 18 inches in diameter and 10 to 40 feet long. They are suspended with their open ends attached to a manifold. The number of bags can vary from a few hundreds to a thousand or more depending upon the size of the bag house. Bag houses are constructed as single or compartmental units. In both cases, the bags are housed in a shell made of rigid metal material. Occasionally, it is necessary to include insulation with the shell when treating high temperature flue gas. This is done to prevent moisture or acid mist from condensing in the unit, causing corrosion and rapid deterioration of the bag house.

Hoppers are used to store the collected dust temporarily before it is disposed in a landfill or reused in the process. Dust should be removed as soon as possible to avoid packing which would make removal very difficult. They are usually designed with a 60 degrees slope to allow dust to flow freely from the top of the hopper to the bottom discharge opening. Sometimes

devices such as strike plates, poke holes, vibrators and rappers are added to promote easy and quick discharge. Access doors or ports are also provided. Access ports provide for easier cleaning, inspection and maintenance of the hopper. A discharge device is necessary for emptying the hopper. Discharge devices can be manual (slide gates, hinged doors and drawers) or automatic trickle valves, rotary airlock valves, screw conveyors or pneumatic conveyors).

### **Filter Media**

Woven and felted materials are used to make bag filters. Woven filters are used with low energy cleaning methods such as shaking and reverse air. Felted fabrics are usually used with low energy cleaning systems such as pulse jet cleaning. While selecting the filter medium for bag houses, the characteristics and properties of the carrier gas and dust particles should be considered. The properties to be noted include:

- a) Carrier gas temperature
- b) Carrier gas composition
- c) Gas flow rate
- d) Size and shape of dust particles and its concentration

The abrasion resistance, chemical resistance, tensile strength and permeability and the cost of the fabric should be considered. The fibers used for fabric filters can vary depending on the industrial application. Some filters are made from natural fibers such as cotton or wool. These fibers are relatively inexpensive, but have temperature limitations (< 212 F) and only average abrasion resistance. Cotton is readily available making it very popular for low temperature simple applications. Wool withstands moisture very well and can be made into thick felts easily.

Synthetic fibers such as nylon, orlon and polyester have slightly higher temperature limitations and chemical resistance. Synthetic fibers are more expensive than natural fibers. Polypropylene is the most inexpensive synthetic fiber and is used in industrial applications such as foundries, coal crushers and food industries. Nylon is the most abrasive resistant synthetic fiber making it useful for applications filtering abrasive dusts. Different types of fibers with varying characteristics are available in the market.

### **Fabric Treatment**

Fabrics are usually pre-treated, to improve their mechanical and dimensional stability. They can be treated with silicone to give them better cake release properties. Natural fibers (wool and cotton) are usually preshrunk to eliminate bag shrinkage during operation. Both synthetic and natural fabrics usually undergo processes such as calendaring, napping, singeing, glazing or coating. These processes increase the fabric life and improve dimensional stability and ease of bag cleaning.

- a) Calendaring:

This is the high pressure pressing of the fabric by rollers to flatten, smooth, or decorate the material. Calendaring pushes the surface fibers down on to the body of the filter medium. This is done to increase surface life, dimensional stability and to give a more uniform

surface to bag fabric.

b) Napping:

This is the scraping of the filter surface across metal points or burrs on a revolving cylinder. Napping raises the surface fibers, that provides a number of sites for particle collection by interception or diffusion. Fabrics used for collecting sticky or oily dusts are occasionally napped to provide good collection and bag cleaning ease.

c) Singeing:

This is done by passing the filter material over an open flame, removing any straggly surface fibers. This provides a more uniform surface.

d) Glazing:

This is the high pressure pressing of the fiber at elevated temperatures. The fibers are fused to the body of the filter medium. Glazing improves the mechanical stability of the filter and helps reduce bag shrinkage that occurs from prolonged use.

e) Coating:

Coating or resin treating involves immersing the filter material in natural or synthetic resin such as polyvinyl chloride, cellulose acetate or urea - phenol. This is done to lubricate the woven fibers or to provide high temperature durability or chemical resistance for various fabric material.

### **Operation of a bag house:**

The gas entering the inlet pipe strikes a baffle plate, which causes larger particles to fall into a hopper due to gravity. The carrier gas then flows upward into the tubes and outward through the fabric leaving the particulate matter as a "cake" on the insides of the bags. Efficiency during the pre-coat formation is low, but increases as the pre-coat (cake) is formed, until a final efficiency of over 99% is obtained. Once formed, the pre-coat forms part of the filtering medium, which helps in further removal of the particulate. Thus the dust becomes the actual filtering medium. The bags in effect act primarily as a matrix to support the dust cake. The cake is usually formed within minutes or even seconds. The accumulation of dust increases the air resistance of the filter and therefore filter bags have to be periodically cleaned. They can be cleaned by rapping, shaking or vibration, or by reverse air flow, causing the filter cake to be loosened and to fall into the hopper below. The normal velocities at which the gas is passed through the bags at 0.4-1m/min. There are many types of "filter bags" depending on the bag shape, type of housing and method of cleaning the fabric.

### **Efficiency:**

The efficiency of bag filters may decrease on account of the following factors:

a) **Excessive filter ratios** - 'Filter ratio' is defined as the ratio of the carrier gas volume to gross filter area, per minute flow of the gas. Excessive filter ratios lower particulate removal efficiency and result in increased bag wear. Therefore, low filter ratios are recommended. Therefore, low filter ratios are recommended for high concentration of particulate.

**b) Improper selection of filter media** - While selecting filter media, properties such as temperature resistance, resistance to chemical attack and abrasion resistance should be taken into consideration.

#### Operating Problems:

Various problems during the operation of a bag house are:

a) Cleaning -

At intervals the bags get clogged up with a covering of dust particles that the gas can no longer pass through them. At that point, the bags have to be cleaned by rapping, shaking or by reverse air flow by a pulse jet.

b) Rupture of the cloth -

The greatest problem inherent in cloth filters is the rupture of cloth, which results from shaking. It is often difficult to locate ruptures and when they're found the replacement time is often considerable.

c) Temperature -

Fabric filters will not perform properly if a gross temperature overload occurs. If the gas temperature is expected to fluctuate, a fiber material that will sustain the upper temperature fluctuation must be selected.

Also, whenever the effluent contains a reactive gas like  $\text{SO}_2$  which can form an acid whenever the temperature in the bag house falls below the dew point it can create problems. Sometimes it may even be necessary to provide an auxiliary heater to make sure that the temperature in the bag house does not fall below acid gas dew point.

d) Bleeding -

This is the penetration of the fabric by fine particles, which is common in fabric filtration. It can occur if the weave is too open or the filter ratio is very high. The solution is to use a double layer material or a thick woven fabric.

e) Humidity -

This is a common and important problem, especially if the dust is hygroscopic. It would therefore be advisable to maintain moisture free conditions within the bag house, as a precautionary measure.

f) Chemical attack -

This is another problem associated with fabric filters. The possibility of chemical attack due to corrosive chemicals present in the effluent. A proper choice of fabric filter will avoid this problem.

#### Filter cleaning mechanisms:

The following mechanisms are used for cleaning the filters in a bag house:

- i) Rapping
- ii) Shaking

- iii) Reverse air flow (back wash)
- iv) Pulse jet

### **Multi-Compartment Type Bag House:**

If the requirements of the process being controlled are such that continuous operation is necessary, the bag filter must be of a multi-compartment type to allow individual units of the bag filter to be successively off-stream during shaking. This is achieved either manually in small units or by programming control in large, fully automatic units. In this case, sufficient cloth area must be provided to ensure that the filtering efficiency will not be reduced during shaking off periods, when any one of the units is off-stream.

The advantages of a fabric filter are:

- i) High collection efficiencies for all particle sizes, especially for particles smaller than 10 micron in diameter.
- ii) Simple construction and operation.
- iii) Nominal power consumption.
- iv) Dry disposal of collected material.

The disadvantages of a fabric filter are:

- i) Operating limits are imposed by high carrier gas temperatures, high humidity and other parameters.
- ii) High maintenance and fabric replacement costs. Bag houses are difficult to maintain because of the difficulty in finding and replacing even a single leaking bag. Also as general rule, about 1/4th of the bags will need replacement every year.
- iii) Large size of equipment.
- iv) Problems in handling dusts which may abrade, corrode, or blind the cloth.

The applications of a fabric filter are:

Fabric filters find extensive application in the following industries and operations:

- i) Metallurgical industry
- ii) Foundries
- iii) Cement industry
- iv) Chalk and lime plants
- v) Brick works
- vi) Ceramic industry
- vii) Flour mills

Cost:

A bag filter is comparatively expensive to install. Its power consumption is moderate. In most cases, the maintenance cost is high because the bags have to be repaired or replaced regularly. The nature of the gas and the dust decide the frequency of such maintenance work.

## LECTURE-40

**NATIONAL AMBIENT AIR QUALITY STANDARDS  
CENTRAL POLLUTION CONTROL BOARD  
NOTIFICATION**

New Delhi, the 18th November, 2009

No. B-29016/20/90/PCI-L—In exercise of the powers conferred by Sub-section (2) (h) of section 16 of the Air (Prevention and Control of Pollution) Act, 1981 (Act No.14 of 1981), and in supersession of the Notification No(s). S.O. 384(E), dated 11<sup>th</sup> April, 1994 and S.O. 935(E), dated 14<sup>th</sup> October, 1998, the Central Pollution Control Board hereby notify the National Ambient Air Quality Standards with immediate effect, namely:-

### NATIONAL AMBIENT AIR QUALITY STANDARDS

S. No.	Pollutant	Time Weighted Average	Concentration in Ambient Air		
			Industrial, Residential, Rural and Other Area	Ecologically Sensitive Area (notified by Central Government)	Methods of Measurement
(1)	(2)	(3)	(4)	(5)	(6)
1	Sulphur Dioxide (SO <sub>2</sub> ), µg/m <sup>3</sup>	Annual* 24 hours**	50 80	20 80	- Improved West and Gaeke -Ultraviolet fluorescence
2	Nitrogen Dioxide (NO <sub>2</sub> ), µg/m <sup>3</sup>	Annual* 24 hours**	40 80	30 80	- Modified Jacob & Hochheiser (Na-Arsenite) - Chemiluminescence
3	Particulate Matter (size less than 10µm) or PM <sub>10</sub> µg/m <sup>3</sup>	Annual* 24 hours**	60 100	60 100	- Gravimetric - TOEM - Beta attenuation
4	Particulate Matter (size less than 2.5µm) or PM <sub>2.5</sub> µg/m <sup>3</sup>	Annual* 24 hours**	40 60	40 60	- Gravimetric - TOEM - Beta attenuation
5	Ozone (O <sub>3</sub> ) µg/m <sup>3</sup>	8 hours** 1 hour**	100 180	100 180	- UV photometric - Chemiluminescence - Chemical Method
6	Lead (Pb) µg/m <sup>3</sup>	Annual* 24 hours**	0.50 1.0	0.50 1.0	- AAS /ICP method after sampling on EPM 2000 or equivalent filter paper - ED-XRF using Teflon filter
7	Carbon Monoxide (CO) mg/m <sup>3</sup>	8 hours** 1 hour**	02 04	02 04	- Non Dispersive Infra Red (NDIR) spectroscopy
8	Ammonia (NH <sub>3</sub> ) µg/m <sup>3</sup>	Annual* 24 hours**	100 400	100 400	-Chemiluminescence -Indophenol blue method

(1)	(2)	(3)	(4)	(5)	(6)
9	Benzene (C <sub>6</sub> H <sub>6</sub> ) µg/m <sup>3</sup>	Annual*	05	05	- Gas chromatography based continuous analyzer - Adsorption and Desorption followed by GC analysis
10	Benzo(a)Pyrene (BaP) - particulate phase only, ng/m <sup>3</sup>	Annual*	01	01	- Solvent extraction followed by HPLC/GC analysis
11	Arsenic (As), ng/m <sup>3</sup>	Annual*	06	06	- AAS /ICP method after sampling on EPM 2000 or equivalent filter paper
12	Nickel (Ni), ng/m <sup>3</sup>	Annual*	20	20	- AAS /ICP method after sampling on EPM 2000 or equivalent filter paper

\* Annual arithmetic mean of minimum 104 measurements in a year at a particular site taken twice a week 24 hourly at uniform intervals.

\*\* 24 hourly or 08 hourly or 01 hourly monitored values, as applicable, shall be complied with 98% of the time in a year. 2% of the time, they may exceed the limits but not on two consecutive days of monitoring.

Note. — Whenever and wherever monitoring results on two consecutive days of monitoring exceed the limits specified above for the respective category, it shall be considered adequate reason to institute regular or continuous monitoring and further investigation.

SANT PRASAD GAUTAM, Chairman  
[ADVT-III/4/184/09/Exty.]

Note: The notifications on National Ambient Air Quality Standards were published by the Central Pollution Control Board in the Gazette of India, Extraordinary vide notification No(s). S.O. 384(E), dated 11<sup>th</sup> April, 1994 and S.O. 935(E), dated 14<sup>th</sup> October, 1998.